

ДОПОЛНИТЕЛЬНЫЕ АУТРИГЕРЫ

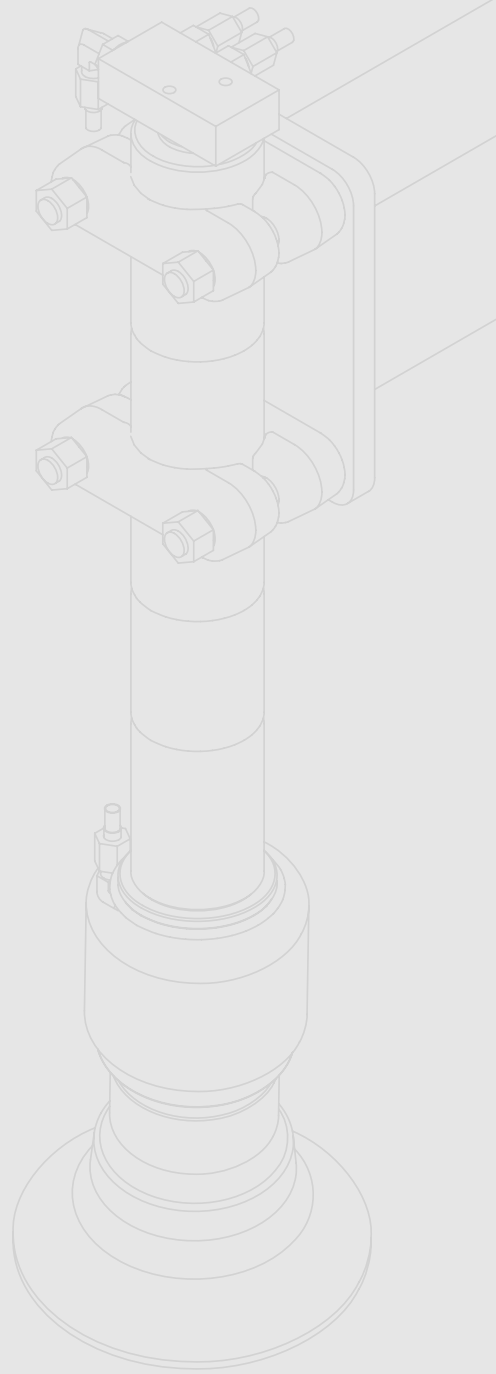

FASSI

www.fassi.by



Содержание

ДОПОЛНИТЕЛЬНЫЕ АУТРИГЕРЫ	стр.
60801F - 61801F/CE	6
60802ME - 60802ME/CE - 60803ME/CE	7
210801F	8
210802ME - 210802ME/CE	9
210803ME - 210803ME/CE	10
211801F/CE	11
215800HE - 215800HE/CE - 215800HS/CE	12
290800HE - 290800HE/CE - 290800HS/CE	13
330802HE - 330802HE/CE - 330802HS/CE	14
391800HE	15
415800HE - 415800HE/CE - 415800HS/CE	16
415802HE - 415802HE/CE - 415802HS/CE	17
541800HE - 541800HE/CE - 541800HS/CE	18
700802HE - 700802HE/CE - 700802HS/CE	19
752801HE - 752801HE/CE - 752801HS/CE	20
752802HE - 752802HE/CE - 752802HS/CE	21
1150A140 - 1150A140/CE - 1150A140S/CE	22
1400A140 - 1400A140/CE - 1400A140S/CE	23
1400A203 - 1400A203/CE	24
1400A303 - 1400A303/CE	25
1400A313 - 1400A313/CE	26
1950A203/CE	27



	61801F	608023ME	210801F	210802ME	210803ME	211801F	211800HE(HS)	290800HE(HS)	330802HE(HS)	391000HE	415800HE(HS)	415802HE(HS)	541800HE(HS)	708002HE(HS)	752801HE(HS)	752802HE(HS)	11504140(S)	14004140(S)	1400A203	1400A303	1400A313	1950A203		
F26A.0 active	•	•																						
F30C.Y0 active	•	•																						
F32A.0 active	•	•																						
F40B.0 active	•	•																						
F50A.0 active / e-active	•	•																						
F55A.0 e-active	•	•																						
F65B.0 active / e-active	•	•																						
F65B.1 dynamic / e-dynamic	•	•																						
F70B.0 e-active	•	•																						
F70B.1 e-dynamic	•	•																						
F85B.0 active / e-active	•	•																						
F85B.1 dynamic / e-dynamic	•	•	•	•	•	•	•																	
F85B.2 dynamic / e-dynamic	•	•	•	•	•	•	•																	
F90B.0 e-active	•	•																						
F90B.1 e-dynamic	•	•																						
F95A.0 active / e-active	•	•																						
F100B.1 xe-dynamic	•	•	•	•	•	•	•																	
F100B.2 xe-dynamic	•	•	•	•	•	•	•																	
F105A.0 e-active			•	•	•	•	•																	
F110B.0 active / e-active			•	•	•	•	•	•																
F110B.1 dynamic / e-dynamic			•	•	•	•	•	•																
F110B.2 dynamic / e-dynamic			•	•	•	•	•	•																
F20B.0 e-active			•	•	•	•	•	•																
F20B.1 e-dynamic			•	•	•	•	•	•																
F20B.2 e-dynamic			•	•	•	•	•	•																
F25A.1 xe-dynamic			•	•	•	•	•	•																
F25A.2 xe-dynamic			•	•	•	•	•	•																
F35A.0 active / e-active			•	•	•	•	•	•																
F35A.2 dynamic / e-dynamic			•	•	•	•	•	•																
S serie			•	•	•	•	•	•																
F155A.0 active / e-active			•	•	•	•	•	•																
F155A.2 dynamic / e-dynamic			•	•	•	•	•	•																
F165A.0 e-active			•	•	•	•	•	•																
F165A.2 e-dynamic			•	•	•	•	•	•																
F175A.0 active / e-active			•	•	•	•	•	•																
F175A.2 dynamic / e-dynamic			•	•	•	•	•	•																
F185A.2 xe-dynamic			•	•	•	•	•	•																
F195A.0 active / e-active			•	•	•	•	•	•																
F195A.2 dynamic / e-dynamic			•	•	•	•	•	•																
F215A.0 active / e-active			•	•	•	•	•	•																
F215A.2 dynamic / e-dynamic			•	•	•	•	•	•																
F255A.0 e-active			•	•	•	•	•	•																
F255A.2 e-dynamic			•	•	•	•	•	•																
F245A.0 active / e-active			•	•	•	•	•	•																
F245A.2 e-dynamic			•	•	•	•	•	•																
F255A.2 xe-dynamic			•	•	•	•	•	•																

	61801F	608023ME	210801F	210802ME	210803ME	211801F	215800HE(HS)	290800HE(HS)	330802HE(HS)	391600HE	415800HE(HS)	415802HE(HS)	541800HE(HS)	700802HE(HS)	752801HE(HS)	752802HE(HS)	1150A140(S)	1400A140(S)	1400A203	1400A303	1400A313	1950A203	
F275A.0 e-active																							
F275A.2 e-dynamic																							
F295A.2 e-dynamic																							
F295RA.2 e-dynamic																							
F305A.2 xe-dynamic																							
F315A.2 e-dynamic																							
F315RA.2 e-dynamic																							
F335A.2 e-dynamic																							
F335RA.2 e-dynamic																							
F345A.2 xe-dynamic																							
F345RA.2 xe-dynamic																							
F365A.2 e-dynamic																							
F365RA.2 e-dynamic																							
F385A.2 e-dynamic																							
F385RA.2 e-dynamic																							
F390SE																							
F395A.2 xe-dynamic																							
F395RA.2 xe-dynamic																							
F415A.2 e-dynamic																							
F415RA.2 e-dynamic																							
F425A.2 e-dynamic																							
F425RA.2 e-dynamic																							
F455A.2 e-dynamic																							
F455RA.2 e-dynamic																							
F485A.2 xe-dynamic																							
F485RA.2 xe-dynamic																							
F515RA.2 e-dynamic																							
F545RA.2 xe-dynamic																							
F600RA.2 lie-dynamic																							
F660RA.2 lie-dynamic																							
F710RA.2 xlie-dynamic																							
F720RA.2 lie-dynamic																							
F800RA.2 lie-dynamic																							
F820RA.2 xlie-dynamic																							
F950RA.2 lie-dynamic																							
F990RA.2 xlie-dynamic																							
F1150RA.2 xlie-dynamic																							
F1300RA.2 lie-dynamic																							
F1350RA.2 xlie-dynamic																							
F1600RA.2 lie-dynamic																							
F1600RAL.2 lie-dynamic																							
F1650RAL.2 xlie-dynamic																							
F1650RAL.2 lie-dynamic																							
F1950RAL.2 lie-dynamic																							
F2150RA.2 xlie-dynamic																							
F2150RAL.2 xlie-dynamic																							

60801F - 61801F/CE

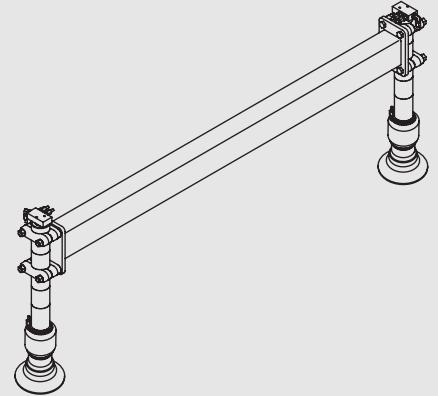
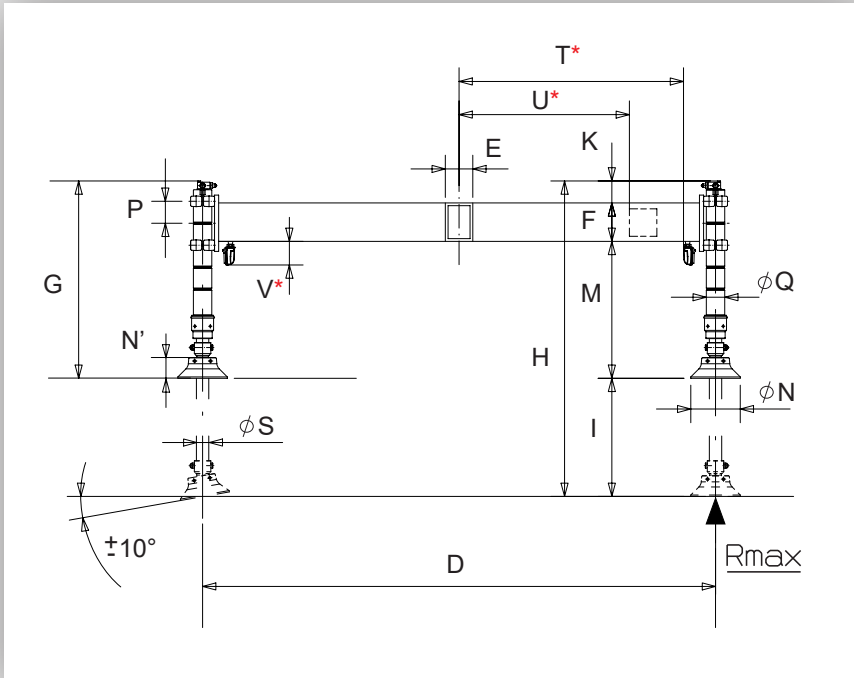

* только для CE версии

ОПЦИИ	D	E	F	G	H	I	K	M	N Ø	N'	Q Ø	S Ø	P	T*	U*	V*	
	1867	90	115	719	1149	430	97 257	507 347	180	75	67 55	45	2x80	817	620	80	68 - 75*
L	1867	90	115	849	1409	560	67 387	667 347	180	75	67 55	45	2x80	817	620	80	74 - 81*

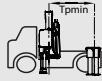

F26A.0 - F40B.0

2000 мм

1580 даН

F50A.0 - F55A.0

2500 мм

F65B.0 - F70B.0

3000 мм

F65B.1 - F70B.1

3000 мм

F85B.0 - F90B.0

3500 мм

F85B.1 - F90B.1 - F100B.1

3500 мм

F85B.2 - F90B.2 - F100B.2

3500 мм



Дополнительные аутригеры

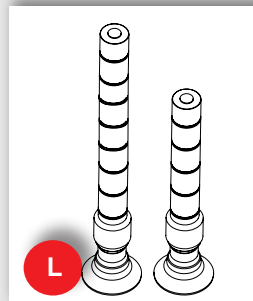
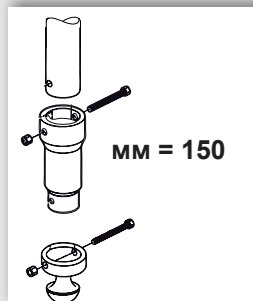
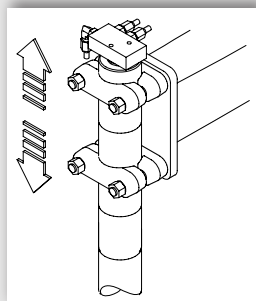

ОПЦИОННО

60802ME - 60802ME/CE - 60803ME/CE

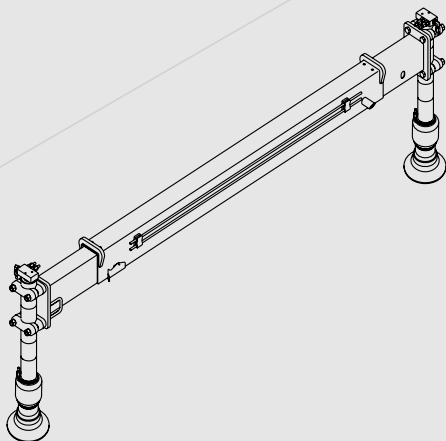

* только для CE версии

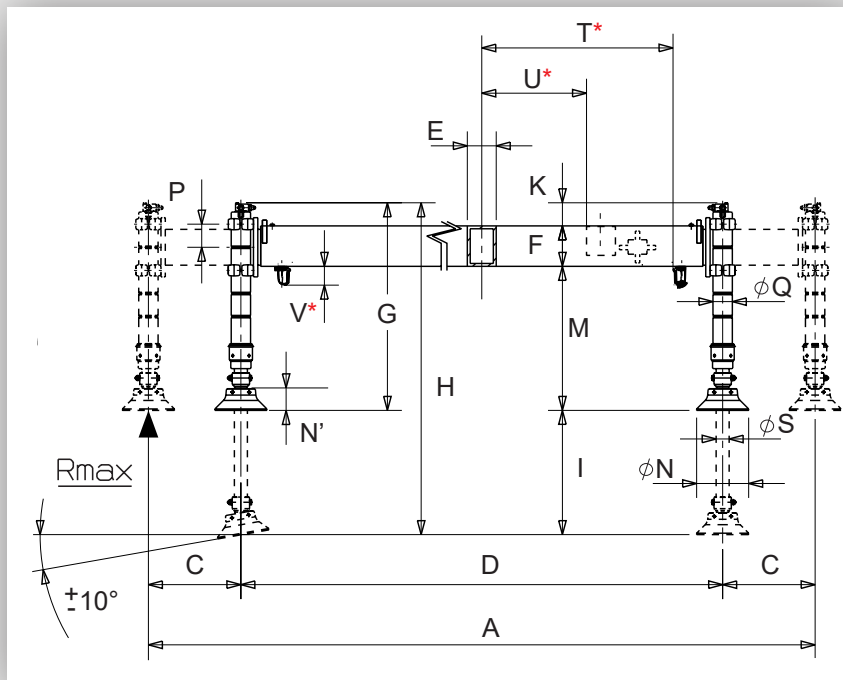

ОПЦИИ	A	C	D	E	F	G	H	I	K	M	N Ø	N'	Q Ø	S Ø	P	T*	U*	V*	
	2507	320	1867	100	140	718	1148	430	80 240	498 338	180	75	67 55	45	2x80	760	463	65	85
L	2507	320	1867	100	140	848	1408	560	50 370	658 338	180	75	67 55	45	2x80	760	463	65	91

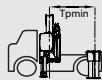

F26A.0 - F40B.0

2000 мм

1380 даН

F50A.0 - F55A.0

2500 мм

F65B.0 - F70B.0

2750 мм

F65B.1 - F70B.1

2750 мм

F85B.0 - F90B.0

3600 мм

F85B.1 - F90B.1 - F100B.1

3600 мм

F85B.2 - F90B.2 - F100B.2

3600 мм

Дополнительные аутригеры

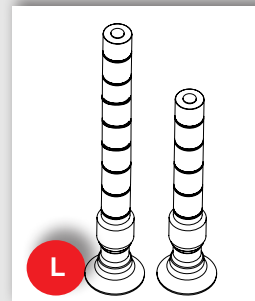
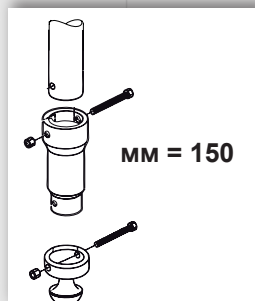
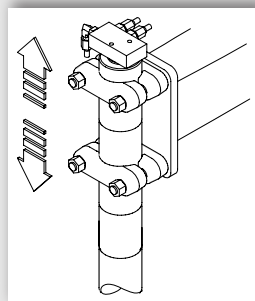
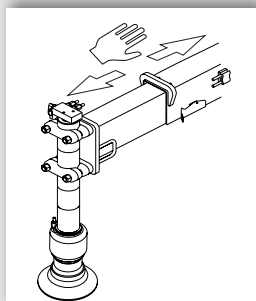

210801F

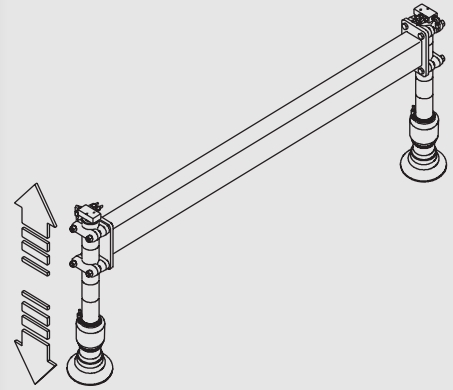
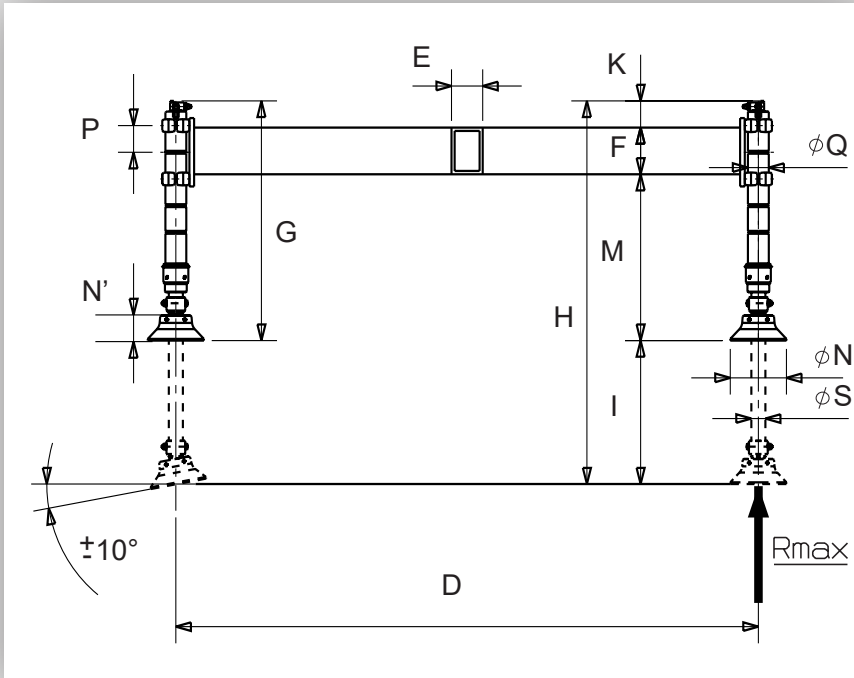

ОПЦИИ	D	E	F	G	H	I	K	M	φN	N'	φQ	φS	P	
	2137	105	150	780	1235	455	132	498	180	75	87	60	2x97	116
R	2377	105	150	780	1235	455	327	303	180	75	75	60	2x97	149
R L	2377	105	150	820	1380	560	102	633	180	75	87	60	3x97	156
L	2137	105	150	820	1380	560	394	342	180	75	75	60	3x97	123

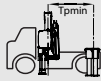

F85B.1 - F165A.2 / F185A.2	3000 мм	3300 мм
F175A.0 - F195A.2	3700 мм	4000 мм
F215A.0 - F235A.2 / F255A.2	4000 мм	4200 мм
F145AS - F160ASXP	3500 мм	
F195AS - F210ASXP	4000 мм	
F215AS - F240ASXP	4500 мм	

4210 даН	3490 даН
----------	----------



Дополнительные аутригеры

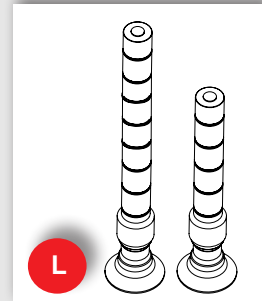
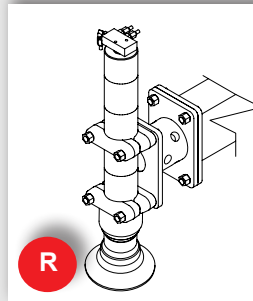
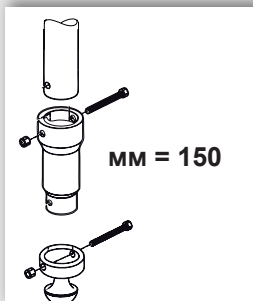
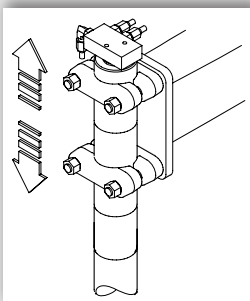

ОПЦИОННО

210802ME - 210802ME/CE

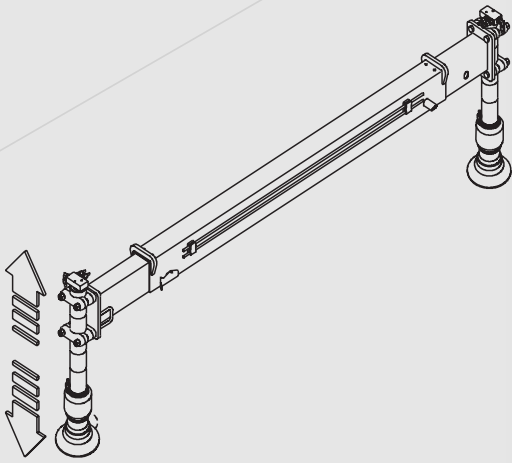

* только для CE версии

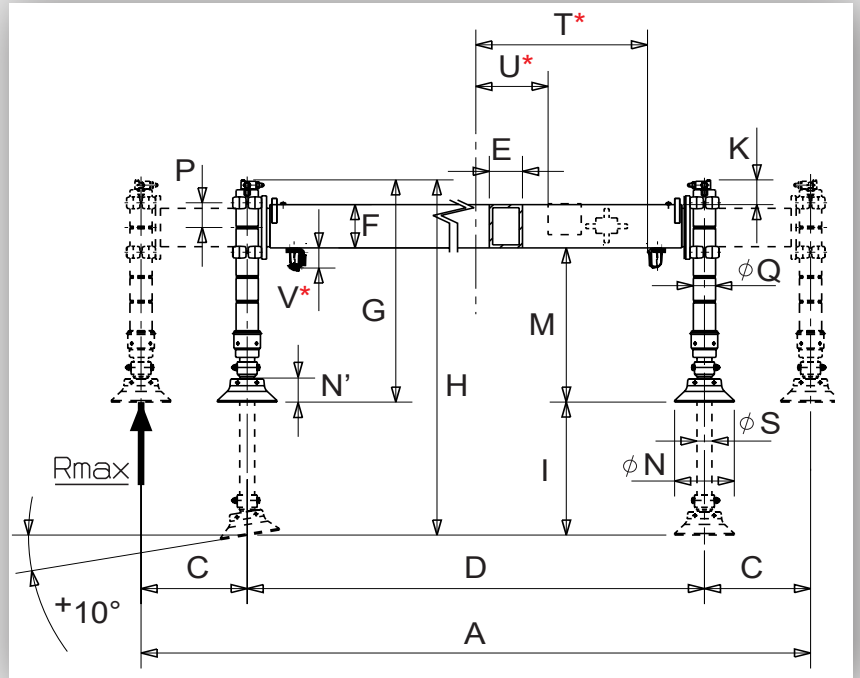

ОПЦИИ	A	C	D	E	F	G	H	I	K	M	φN	N'	φQ	φS	P	T*	U*	V*	⌀
	3563	700	2163	122	177	780	1235	455	116 311	487 292	180	75	87 75	60	2x97	830	597	65	165
R	3853	700	2453	122	177	780	1235	455	116 311	487 292	180	75	87 75	60	2x97	830	597	65	198
R L	3853	700	2453	122	177	885	1445	560	85 378	622 330	180	75	87 75	60	3x97	830	597	65	205
L	3563	700	2163	122	177	885	1445	560	85 378	622 330	180	75	87 75	60	3x97	830	597	65	173

Модель	Трmin	Трmin rot	Модель	Трmin	Трmin rot	Rmax std	Rmax rot
F85B.1 - F90B.1 - F100B.1	3000 мм	3300 мм	F145AS - F160ASXP	4000 мм		3430 даН	3100 даН
F85B.2 - F90B.2 - F100B.2	3000 мм	3300 мм	F195AS - F210ASXP	4500 мм			
F95A.0 - F105A.0	3000 мм	3000 мм	F215AS - F240ASXP	5000 мм			
F110B.0 - F125A.2	3000 мм	3000 мм					
F135A.0 - F165A.2 / F185A.2	3200 мм	3200 мм					
F175A.0	3500 мм	3500 мм					
F175A.2 - F195A.2	4000 мм	4000 мм					
F215A.0 - F235A.2 / F255A.2	4200 мм	4200 мм					

Дополнительные аутригеры

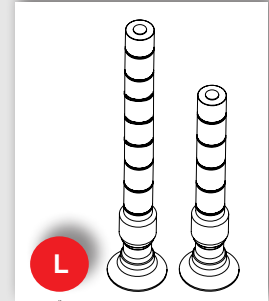
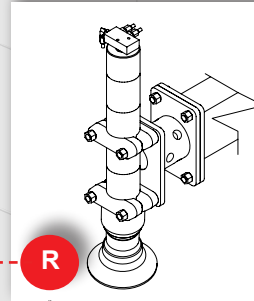
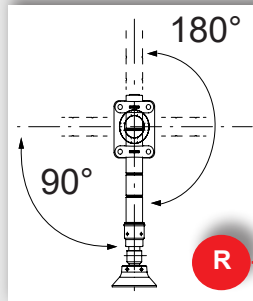
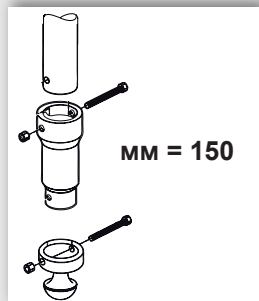
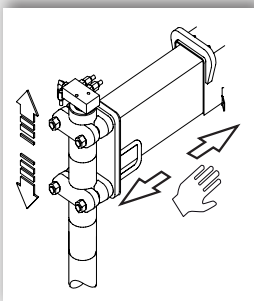

ОПЦИОННО

210803ME - 210803ME/CE

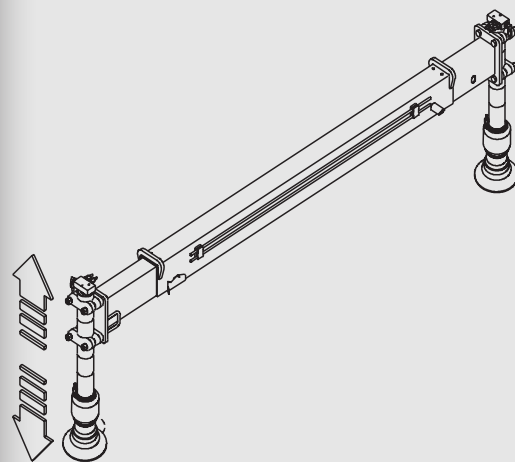
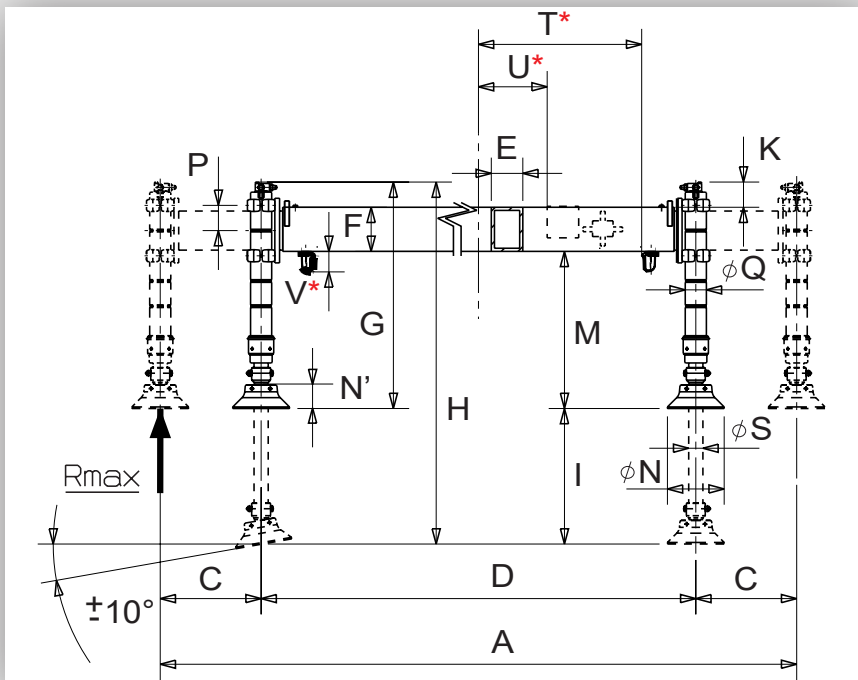

* только для CE версии

ОПЦИИ	A	C	D	E	F	G	H	I	K	M	φN	N'	φQ	φS	P	T*	U*	V*	⊗
	3103	535	2033	122	167	780	1235	455	120 315	492 297	180	75	87 75	60	2x97	900	532	65	156
R	3393	535	2323	122	167	780	1235	455	120 315	492 297	180	75	87 75	60	2x97	900	532	65	190
R L	3393	535	2323	122	167	885	1445	560	85 378	627 334	180	75	87 75	60	3x97	900	532	65	196
L	3103	535	2033	122	167	885	1445	560	85 378	627 334	180	75	87 75	60	3x97	900	532	65	163

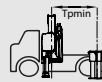
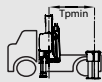

Rmax std



Rmax rot



F85B.1 - F90B.1 - F100B.1

3000 мм 3300 мм

F145AS - F160ASXP 3500 мм

3770 даН

3360 даН

F85B.2 - F90B.2 - F100B.2

3000 мм 3300 мм

F195AS - F210ASXP 4000 мм

F95A.0 - F105A.0

3000 мм 3000 мм

F215AS - F240ASXP 4500 мм

F110B.0 - F125A.2

3000 мм 3000 мм

F135A.0 - F165A.2 / F185A.2

3200 мм 3200 мм

F175A.0 - F175A.2 - F195A.0

3500 мм 3500 мм

F195A.2

4000 мм 4000 мм

F215A.0 - F235A.2 / F255A.2

4200 мм 4000 мм



Дополнительные аутригеры

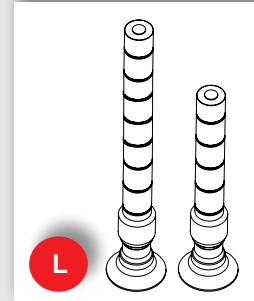
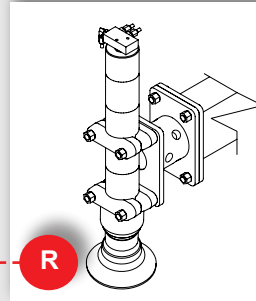
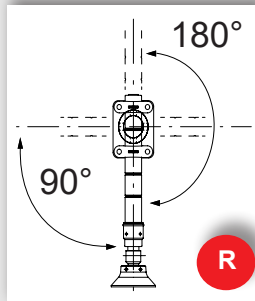
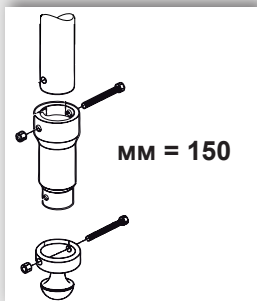
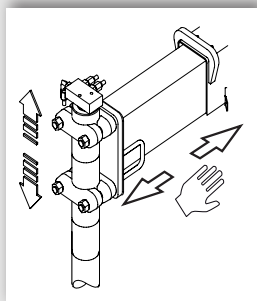

ОПЦИОННО

211801F/CE

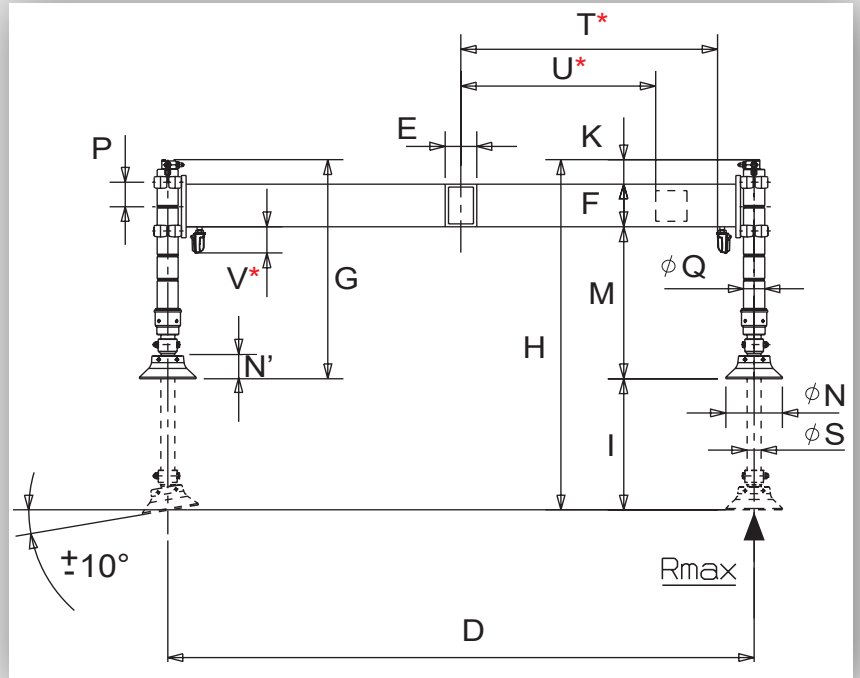
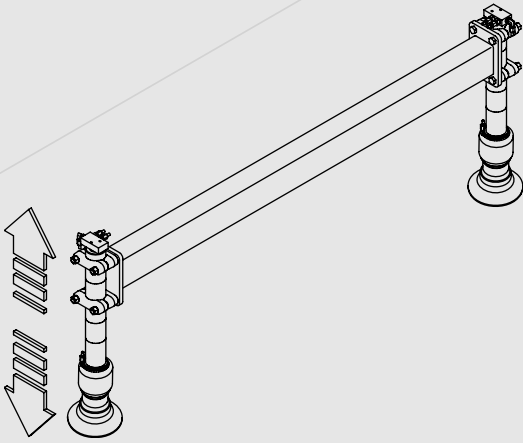

* только для CE версии

ОПЦИИ	D	E	F	G	H	I	K	M	φN	N'	φQ	φS	P	T*	U*	V*	
	2137	105	150	780	1235	455	132	498	180	75	87	60	2x97	817	620	80	126
							327	303			75						
R	2427	105	150	780	1235	455	132	498	180	75	87	60	2x97	817	620	80	159
							327	303			75						
R L	2427	105	150	820	1380	560	102	633	180	75	87	60	3x97	817	620	80	166
							394	342			75						
L	2137	105	150	820	1380	560	102	633	180	75	87	60	3x97	817	620	80	133
							394	342			75						

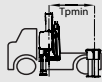

F85B.1 - F165A.2 / F185A.2

3000 мм

3300 мм

4210 даН

3490 даН

F175A.0 - F195A.2

3700 мм

4000 мм

F215A.0 - F235A.2 / F255A.2

4000 мм

4200 мм

F145AS - F160ASXP

3500 мм

F195AS - F210ASXP

4000 мм

F215AS - F240ASXP

4500 мм

Дополнительные аутригеры

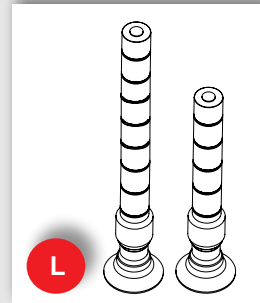
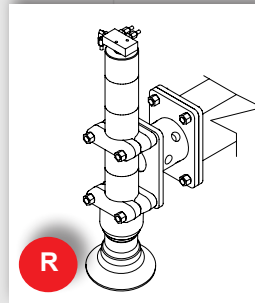
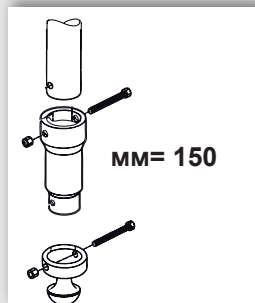
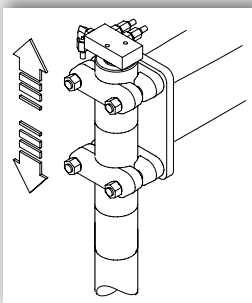

ОПЦИОННО

215800HE - 215800HE/CE - 215800HS/CE

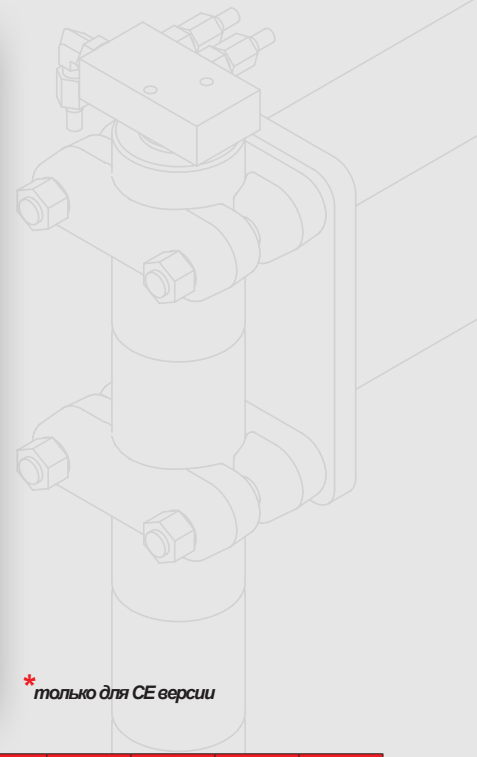
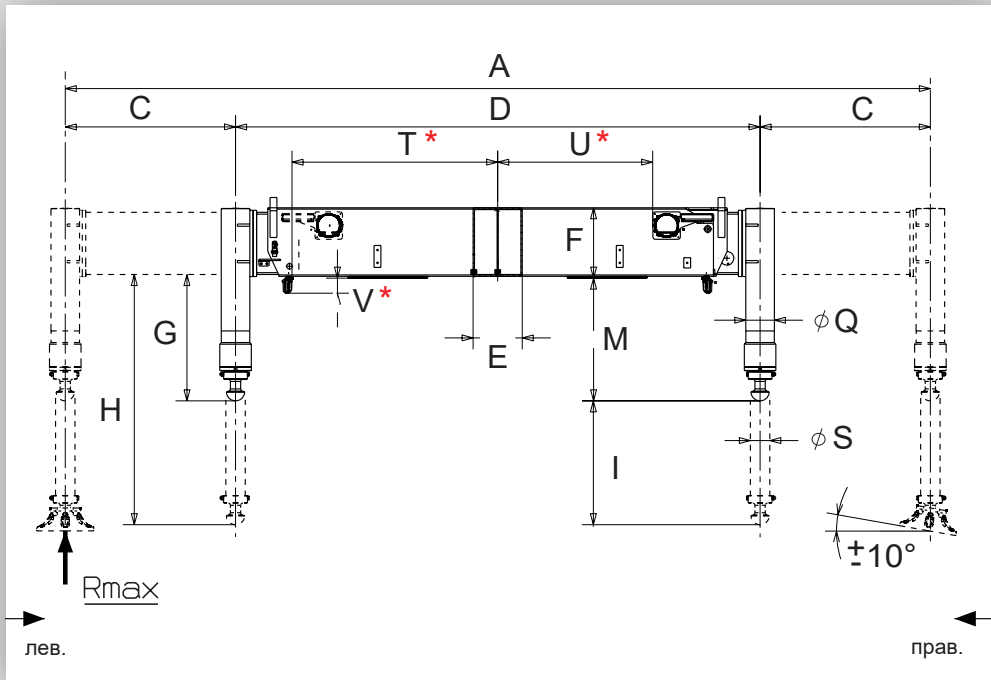

ОПЦИИ	A	C	D	E	F	G	H	I	M	ϕQ	ϕS	T*	U*	V*	
	5080	1395	2290	215	308	553	1095	542	537	125	85	900	678	66	530
R	5150	1395	2360	215	308	934	1551	633	918	125	85	900	678	66	580

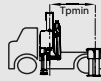

KIT 330K065

F215A.0 - F235A.2 / F255A.2

2000 мм

10000 даН

6 кг

F245A.0 - F275A.2 / F305A.2

2500 мм

F295A.2 / F315A.2 / F345A.2

3000 мм

F295RA.2 / F315RA.2 / F345RA.2

3000 мм

F335A.2 / F365A.2 / F395A.2 - F335RA.2 / F365RA.2 / F395RA.2

3500 мм

F385A.2 / F425A.2 - F385RA.2 / F425RA.2

4000 мм

F415A.2 / F455A.2 / F485A.2 - F415RA.2 / F455RA.2 / F485RA.2

4500 мм



Дополнительные аутригеры

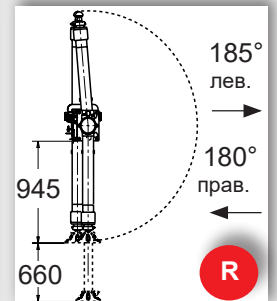
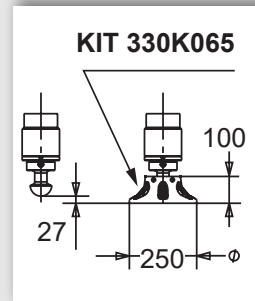
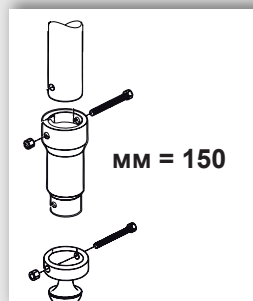
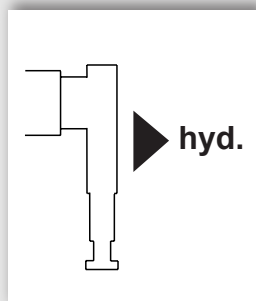
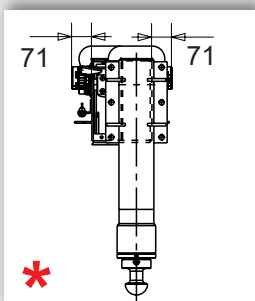

ОПЦИОННО

290800HE - 290800HE/CE - 290800HS/CE

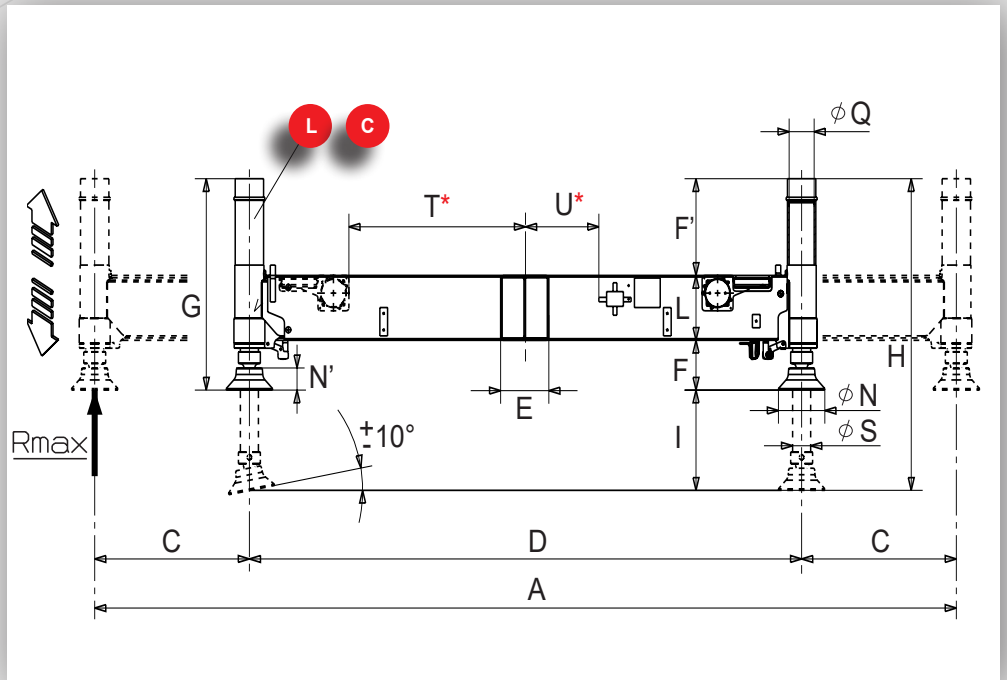

* только для CE версии

	A	C	D	E	F'	F	G	H	I	L	φ N	N'	φ Q	φ S	T*	U*	
L	4142	1000	2142	187	108/554	615/169	943	1493	550	220	180	75	97	70	685	284	340
C	4142	1000	2142	187	108/328	389/169	717	1057	340	220	180	75	97	70	685	284	320

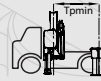
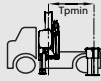

F110B.0 - F135A.2

3000 мм

F155A.0 - F165A.2 / F185A.2

3200 мм

F175A.0 - F175A.2

3500 мм

F195A.0 - F195A.2

3850 мм

F215A.0 / F235A.0

3850 мм

F215A.2 / F235A.2 / F255A.2

4000 мм

F245A.0 / F275A.0

4000 мм

F245A.2 / F275A.2 / F305A.2

4000 мм

F295A.2 / F315A.2 / F345A.2

4200 мм

F295RA.2 / F315RA.2 / F345RA.2

4200 мм

5710 даН

Дополнительные аутригеры

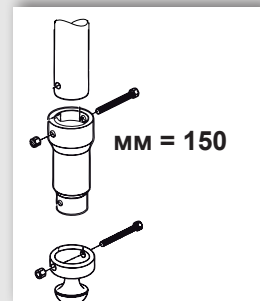
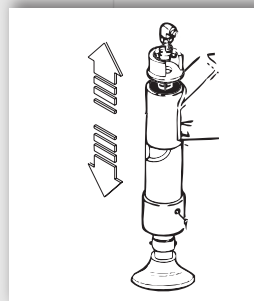
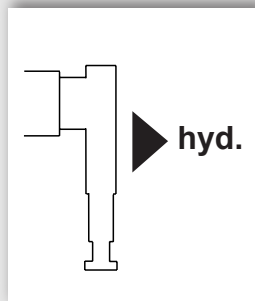
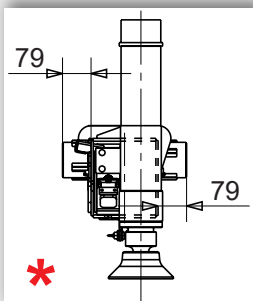

330802HE - 330802HE/CE - 330802HS/CE

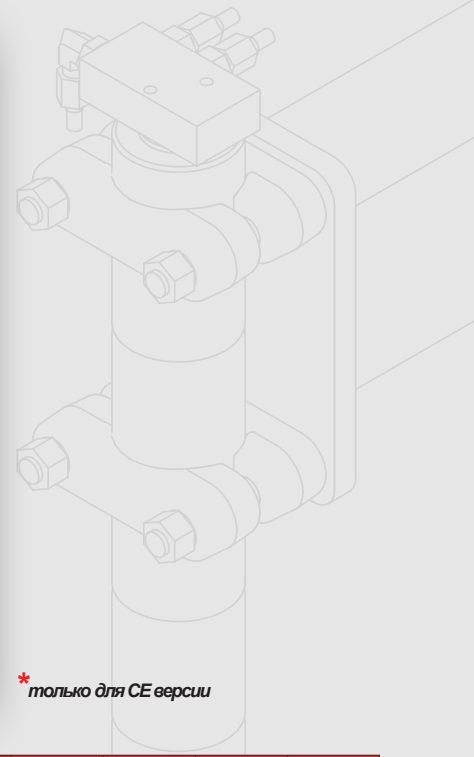
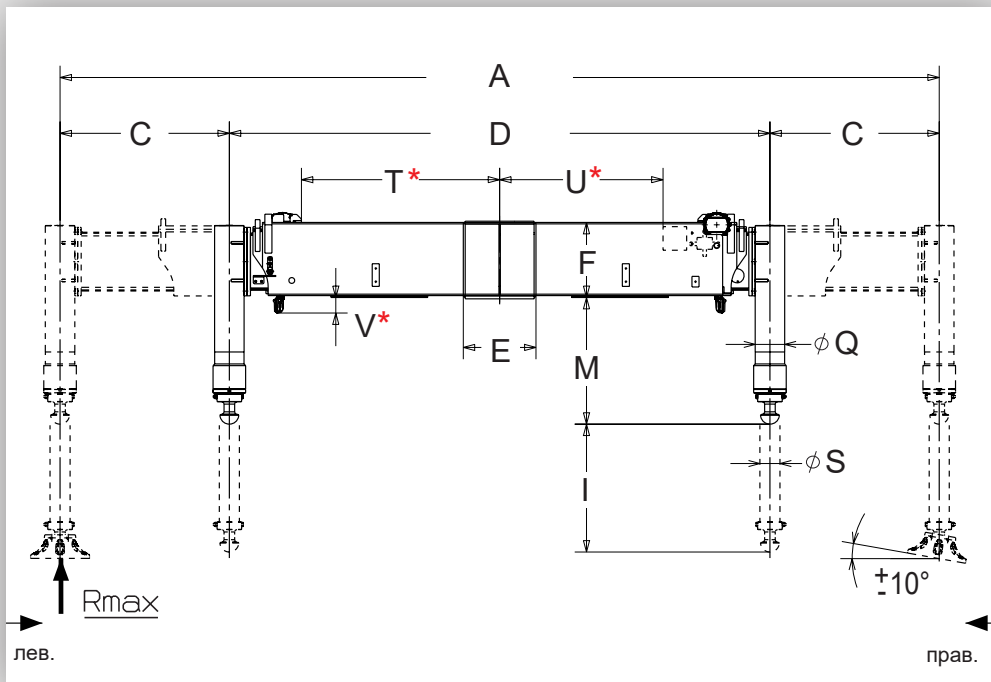

* только для CE версии

ОПЦИИ	A	C	D	E	F	I	M	φQ	φS	T*	U*	V*	
	5990	1850	2290	256	318	542	537	125	85	840	690	66	720
R	6060	1850	2360	256	318	633	913	125	85	840	690	66	770

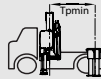

Rmax
14000 даН

KIT 330K065
6 кг

F335A.2 / F365A.2 / F395A.2	3000 мм
F335RA.2 / F365RA.2 / F395RA.2	3000 мм
F385A / F425A.2 - F385RA / F425RA.2	3000 мм
F415A.2 / F455A.2 / F485A.2 - F415RA.2 / F455RA.2 / F485RA.2	3500 мм
F515RA.2 / F545RA.2	3500 мм



Дополнительные аутригеры

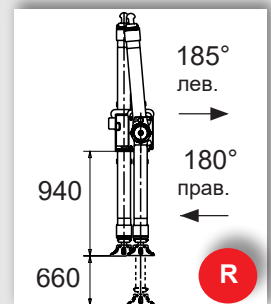
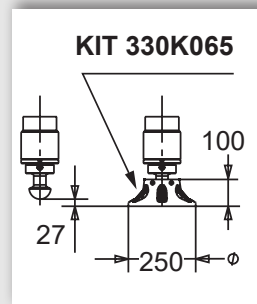
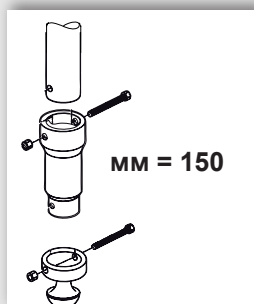
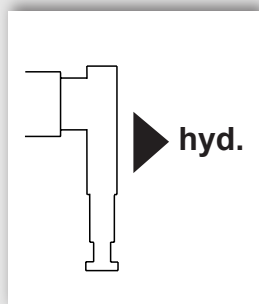
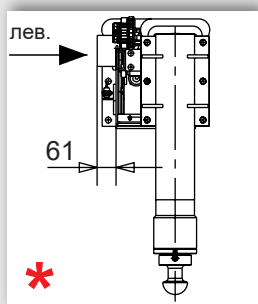

ОПЦИОННО

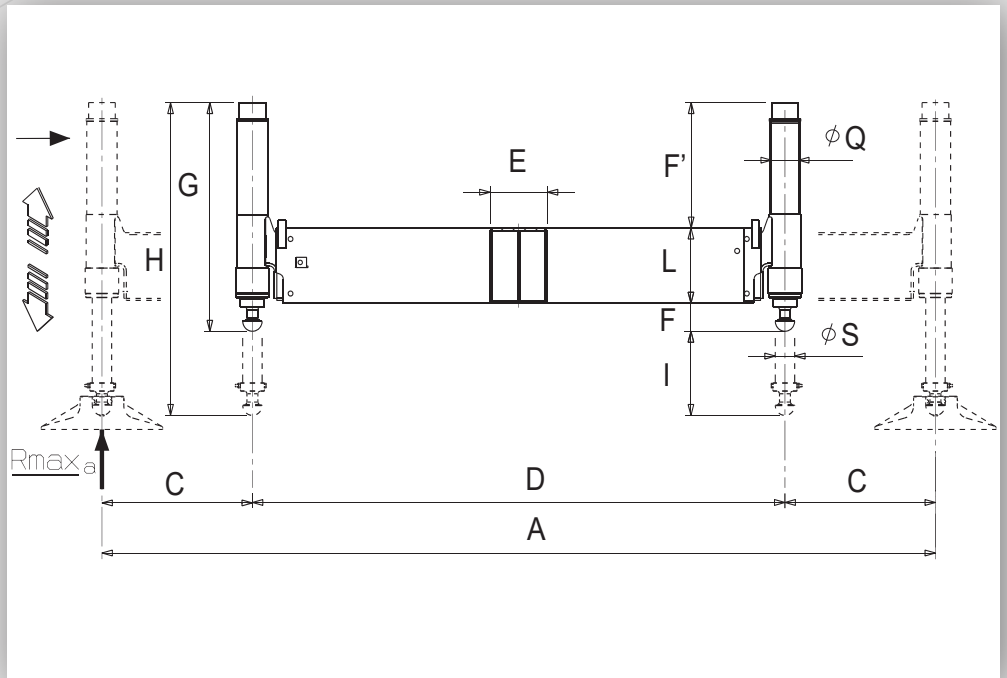

* только для SE версии

A	C	D	E	F'	F	G	H	I	L	φQ	φS	
4984	1395	2194	236	127/493	475/109	897	1407	510	295	112	80	575



F390SE

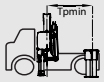

3500 мм

KIT 330K064

14 кг

Дополнительные аутригеры

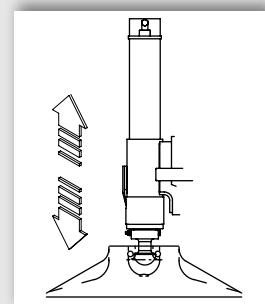
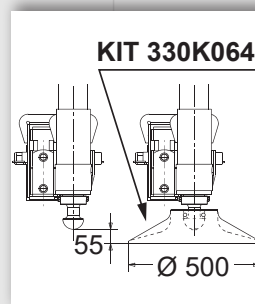
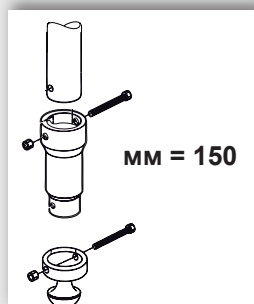
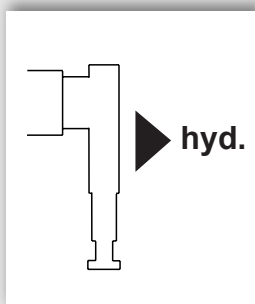

415800HE - 415800HE/CE - 415800HS/CE

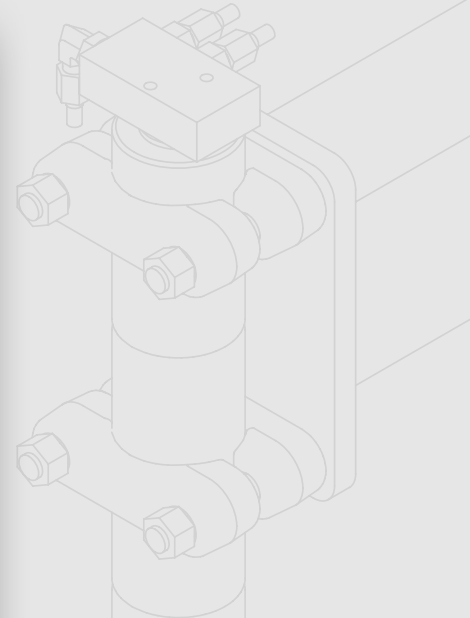
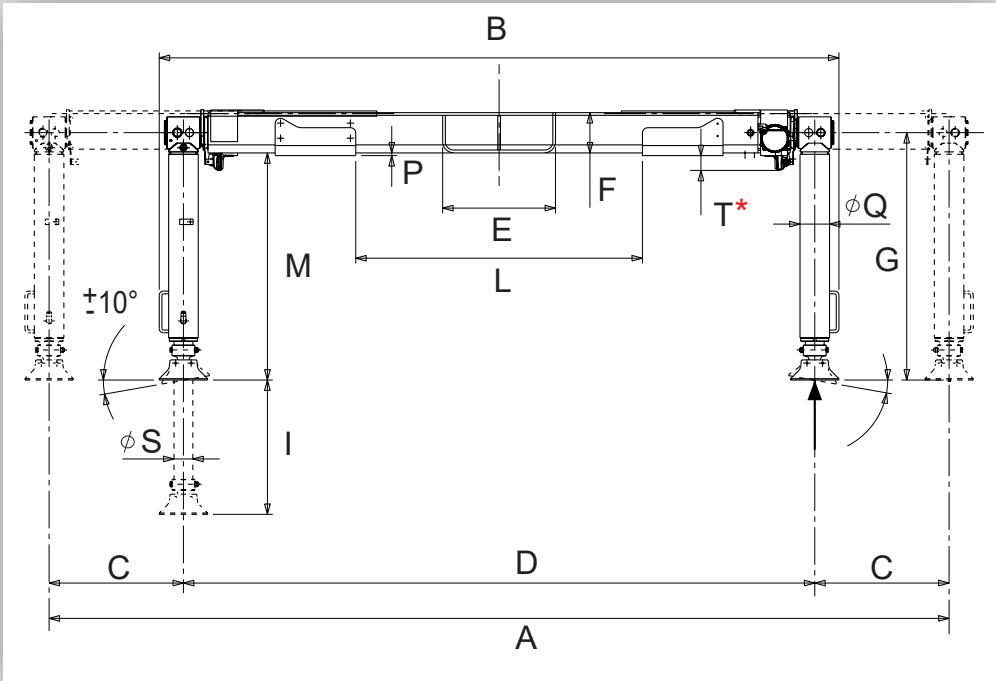

* только для CE версии

	A	B	C	D	E	F	G	I	L	M	P	φ Q	φ S	T*	
	5450	2530	1550	2350	420	150	920	550	1067	847	10	110	70	55	660
C	5450	2530	1550	2350	420	150	780	410	1067	707	10	110	70	55	645

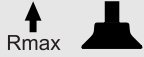
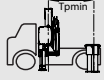

F215A.0 - F275A.2 / F305A.2 5000 мм

F295A.2 - F365RA.2 / F395RA.2 5500 мм

F385A.2 - F485RA.2 6000 мм

R_{max} 9000 даН



Дополнительные аутригеры

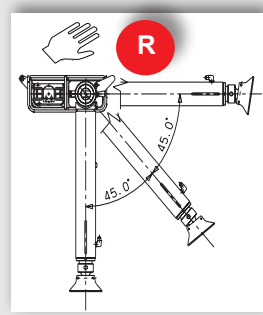
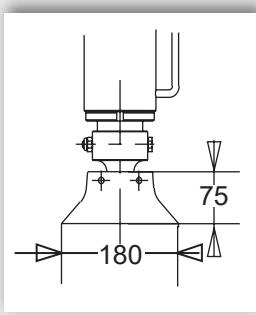
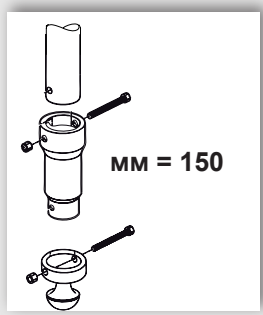
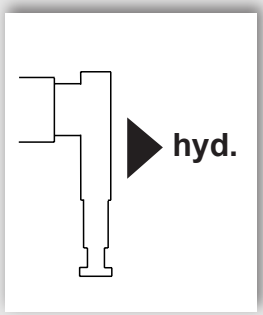

415802HE - 415802HE/CE - 415802HS/CE

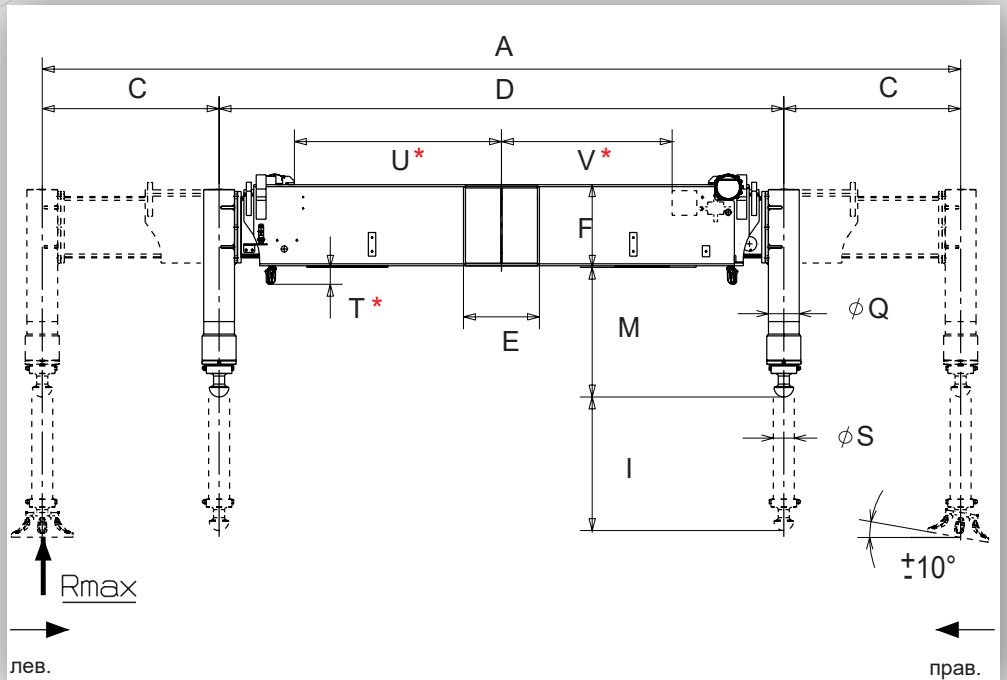

* только для CE версии

ОПЦИИ	A	C	D	E	F	I	M	φ Q	φ S	T*	U*	V*	
	7210	2460	2290	308	335	542	527	125	85	69	840	690	970
R	7280	2460	2360	308	335	648	910	125	85	69	840	690	1040

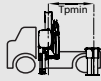

KIT 330K065

F385A.2 / F425A.2

3000 мм

16850 даН

6 кг

F385RA.2 / F425RA.2

3000 мм

F415A.2 / F455A.2 / F485A.2

3500 мм

F415RA.2 / F455RA.2 / F485RA.2

3500 мм

F515RA.2 / F545RA.2

3500 мм

F600RA.2 / F660RA.2 / F710RA.2

4500 мм

Дополнительные аутригеры

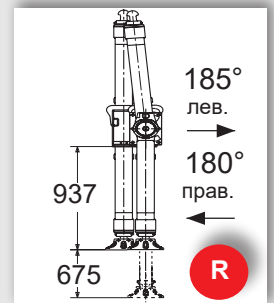
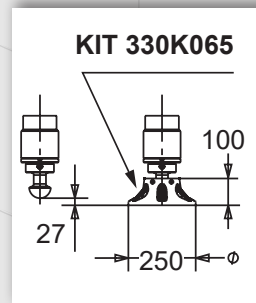
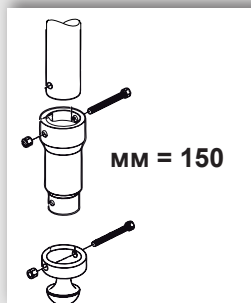
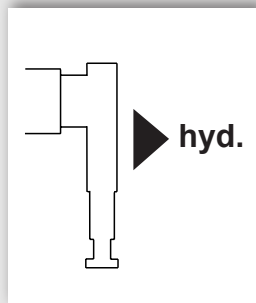
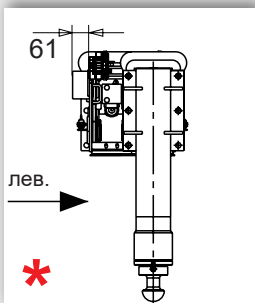

ОПЦИОННО

541800HE - 541800HE/CE - 541800HS/CE

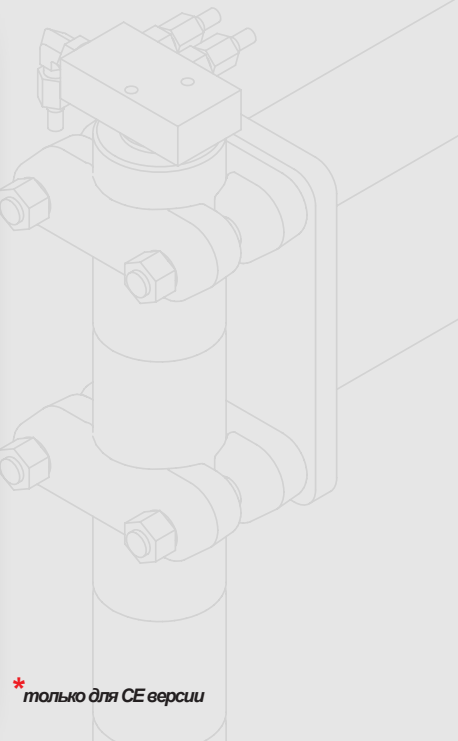
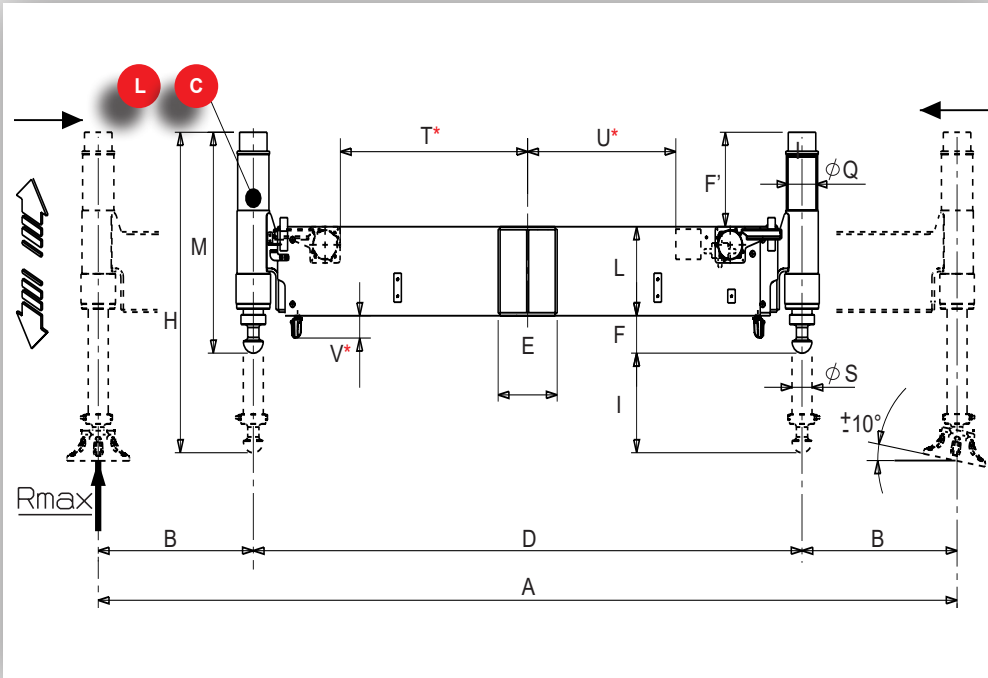

* только для CE версии

	A	B	D	E	F'	F	H	I	L	M	φ Q	φ S	T*	U*	V*	
L	4984	1395	2194	236	127/493	475/109	1407	510	295	897	112	80	750	595	74	570
C	4984	1395	2194	236	127/313	310/124	1062	330	295	732	112	80	750	595	74	555

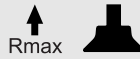
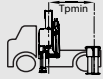

KIT 330K065

F335A.2 / F365A.2 / F395A.2

3500 мм

13040 даН

6 кг

F335RA.2 / F365RA.2 / F395RA.2

3500 мм

F385A.2 / F425A.2

3850 мм

F385RA.2 / F425RA.2

3850 мм

F415A.2 / F455A.2 / F485A.2

4000 мм

F415RA.2 / F455RA.2 / F485RA.2

4000 мм

F515RA.2 / F545RA.2

4000 мм

F600RA.2 / F660RA.2 / F710RA.2

5800 мм



Дополнительные аутригеры

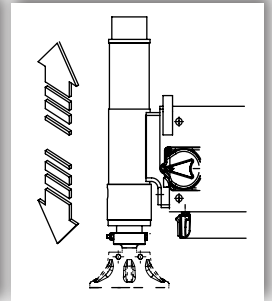
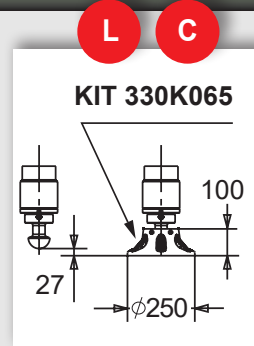
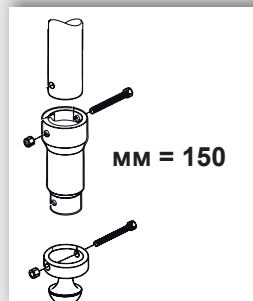
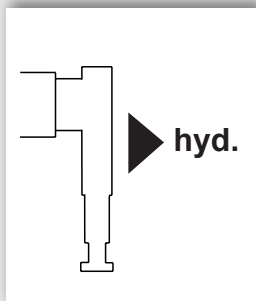
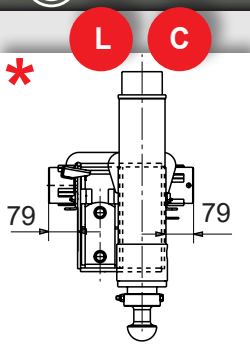

700802HE - 700802HE/CE - 700802HS/CE

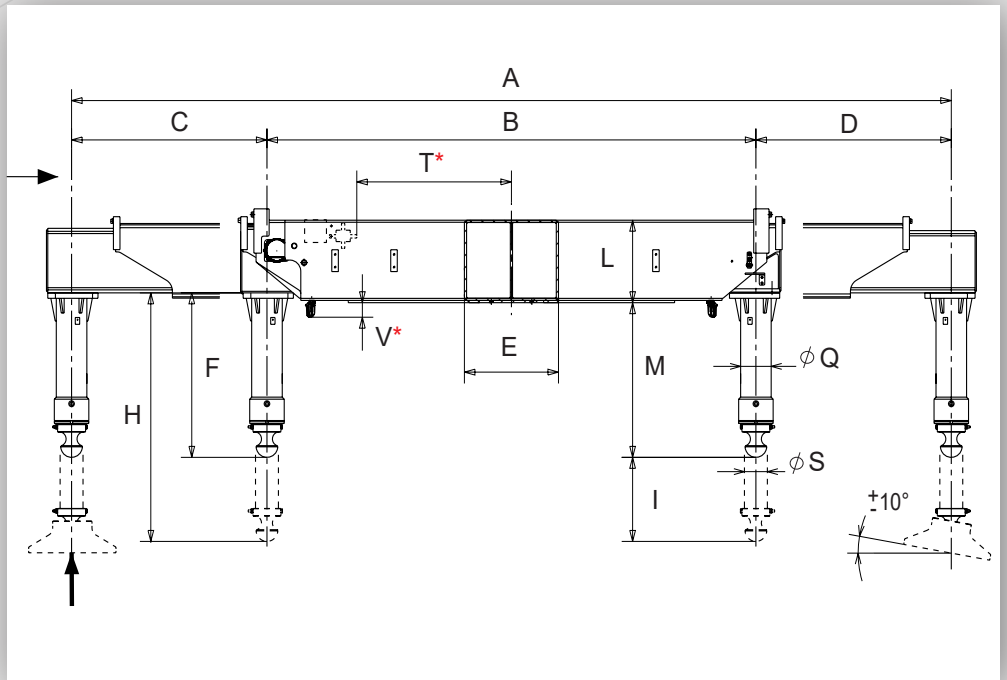

* только для CE версии

	A	B	C	D	E	F	H	I	L	M	ϕQ	ϕS	T*	V*	
L	8290	2240	3100	2950	431	875	1395	520	363	830	140	105	709	64	1495
C	8290	2240	3100	2950	431	725	1095	370	363	680	140	105	709	64	1475

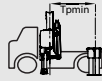

KIT 330K062

F600RA.2 / F660RA.2 / F710RA.2

3000 мм

24500 даН

16 кг

F720RA.2 / F800RA.2 / F820RA.2

3500 мм

F950RA.2 / F990RA.2

4000 мм

F1150RA.2

4500 мм

Дополнительные аутригеры

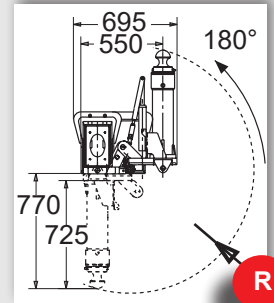
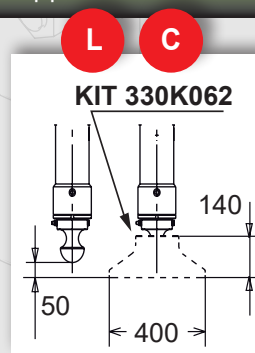
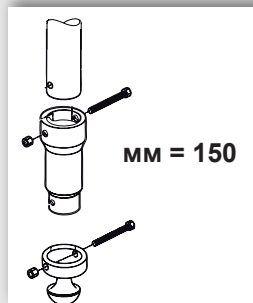
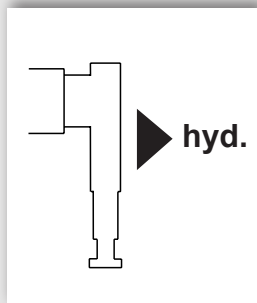
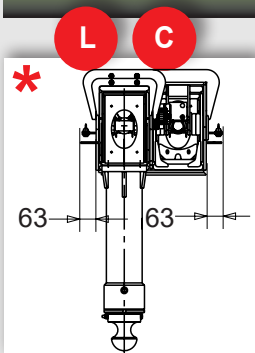

ОПЦИОННО

830

752801HE - 752801HE/GE - 752801HS/GE

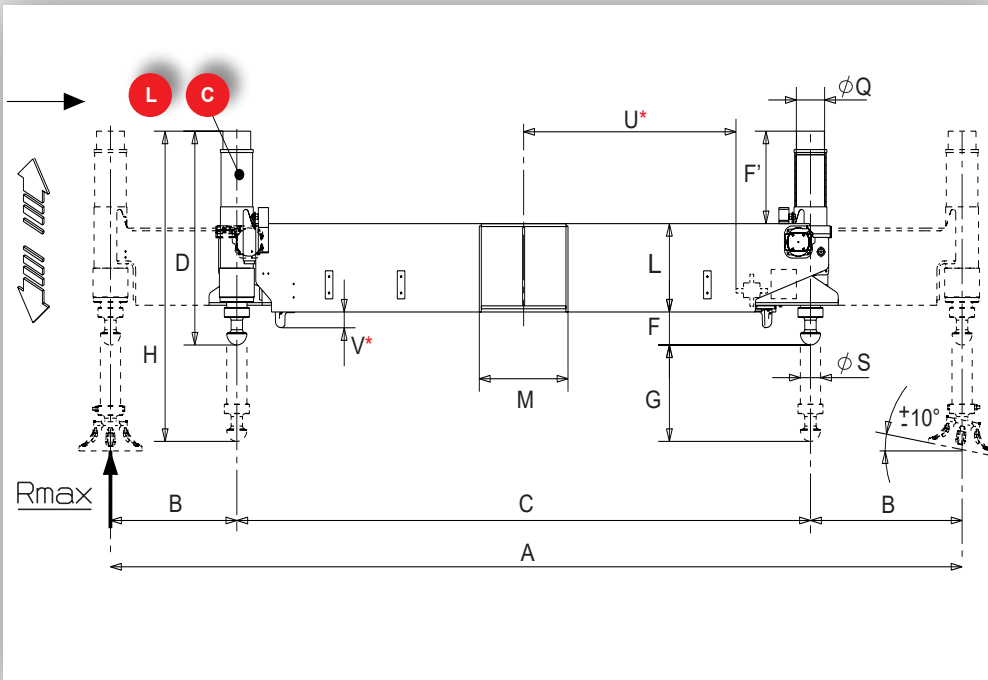

* только для GE версии

	A	B	C	D	F'	F	G	H	L	M	φ Q	φ S	T*	U*	V*	
L	5770	1750	2270	897	131/497	542/176	510	1407	303	351	112	80	965	840	54	805
C	5770	1750	2270	732	131/317	299/113	330	1062	303	351	112	80	965	840	54	795



F720RA.2 / F800RA.2 / F820RA.2

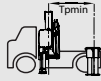

4500 мм

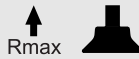

16220 даН

KIT 330K065

6 кг



Дополнительные аутригеры

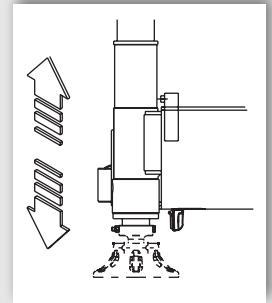
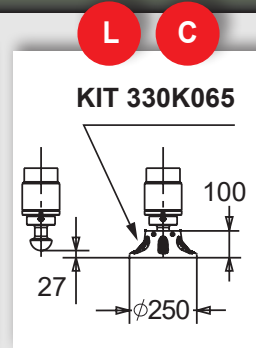
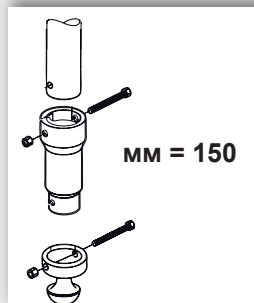
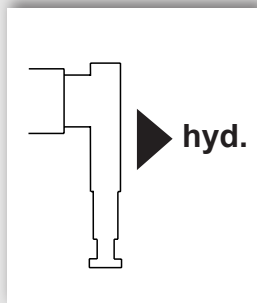
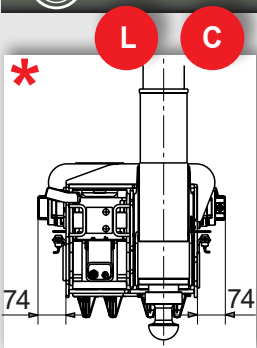

752802HE - 752802HE/CE - 752802HS/CE

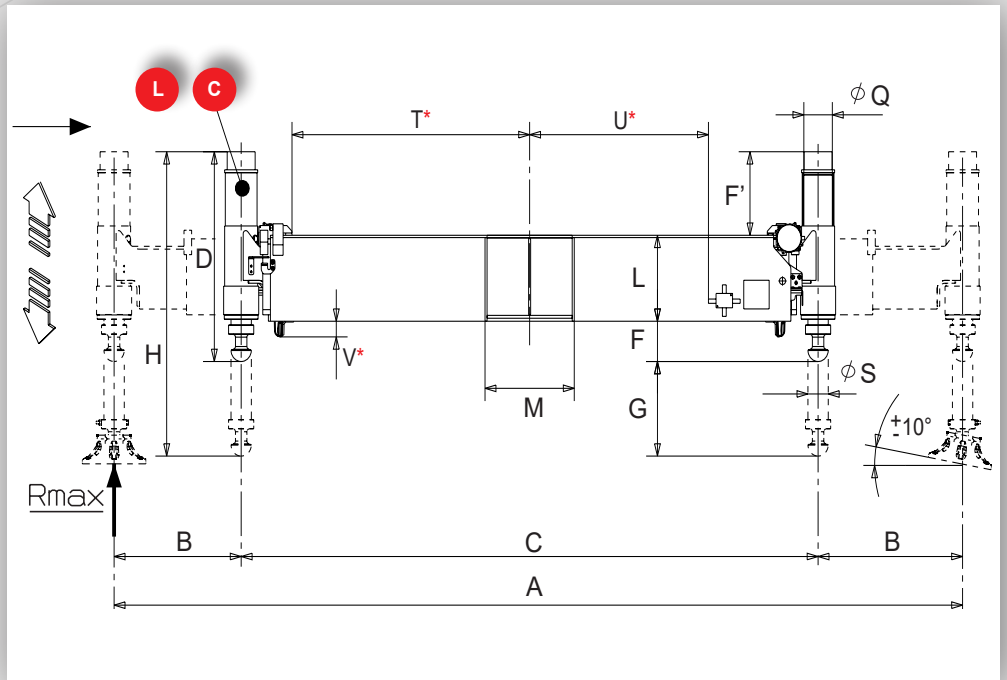

* только для CE версии

	A	B	C	D	F'	F	G	H	L	M	ϕQ	ϕS	T*	U*	V*	
L	6870	2300	2270	897	106/472	508/142	510	1407	300	351	112	80	935	705	55	920
C	6870	2300	2270	732	106/292	328/142	330	1062	300	351	112	80	935	705	55	910

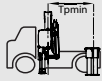

F720RA.2 / F800RA.2 / F820RA.2

5000 мм



14070 даН

KIT 330K065

6 кг

Дополнительные аутригеры

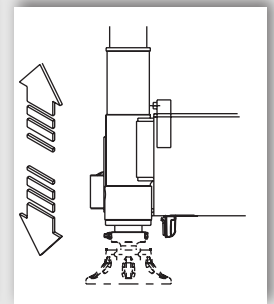
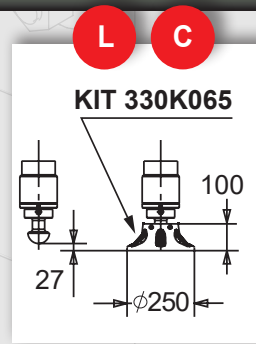
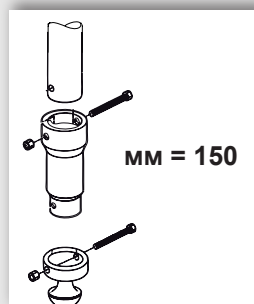
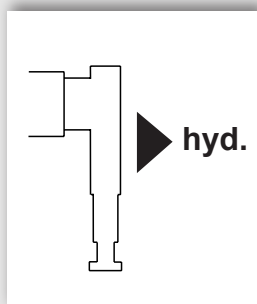
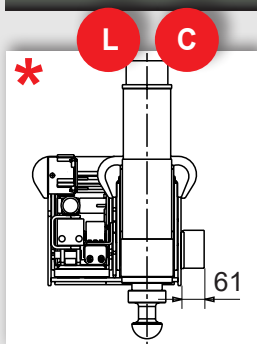

1150A140 - 1150A140/CE - 1150A140S/CE

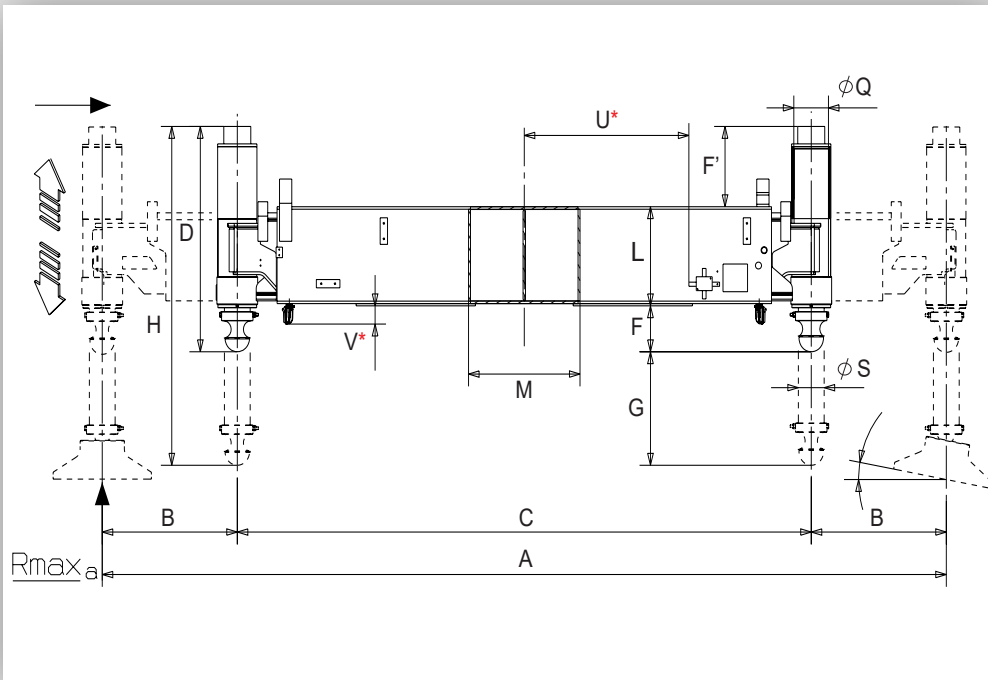

* только для CE версии

A	B	C	D	F	F'	G	H	L	M	φQ	φS	U*	V*	
7538	2600	2338	815	427/167	30/290	410	1225	358	454	140	105	670	65	1350

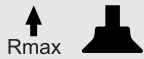
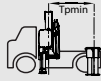

KIT 330K062

F950RA.2 / F990RA.2

3000 мм

21000 даН

16 кг

F1150RA.2

4000 мм

F1300RA.2 / F1350RA.2

4500 мм

F1600RA.2 / F1650RA.2

6000 мм



Дополнительные аутригеры

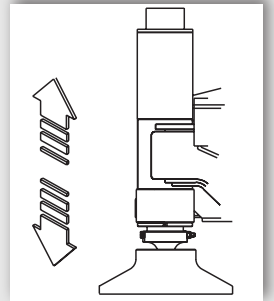
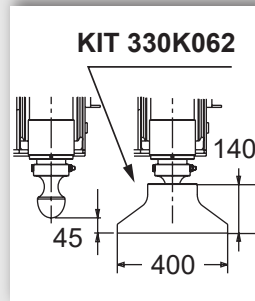
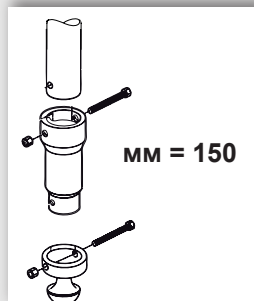
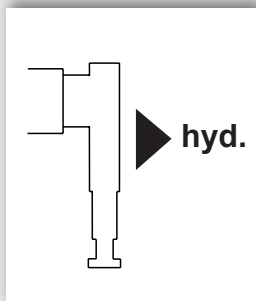
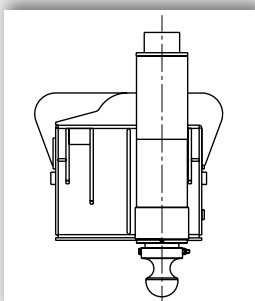

1400A140 - 1400A140/CE- 1400A140S/CE

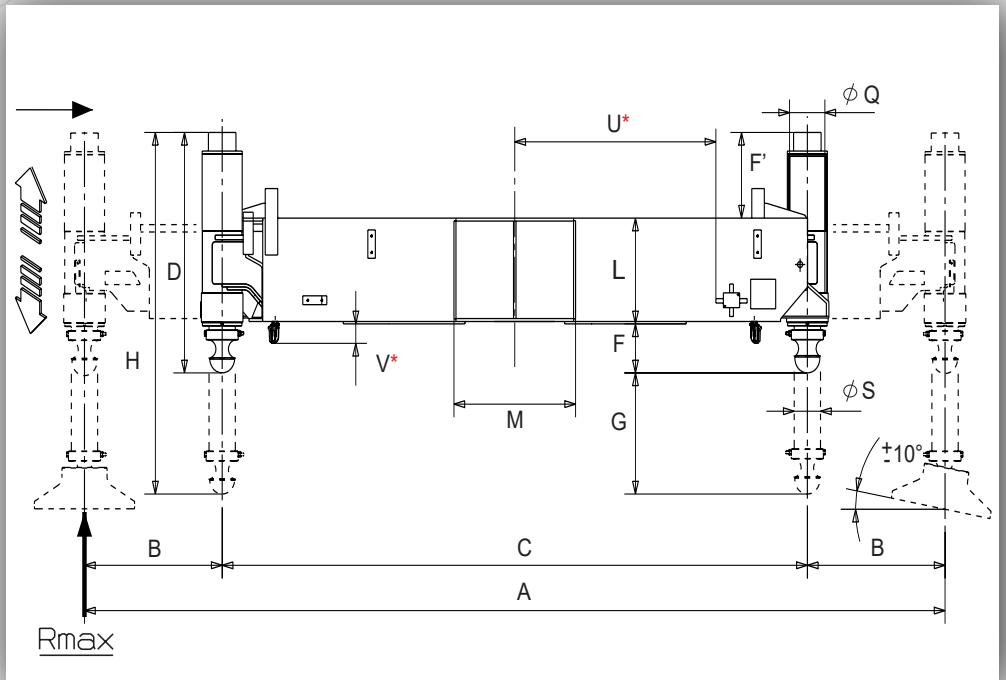

* только для CE версии

A	B	C	D	F	F'	G	H	L	M	ϕQ	ϕS	U*	V*	
8538	3100	2338	815	427/167	30/290	410	1225	358	485	140	105	805	65	1650

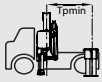

KIT 330K062

F950RA.2 / F990RA.2 3500 мм

18480 даН

16 кг

F1150RA.2 4500 мм

F1300RA.2 / F1350RA.2 5000 мм

Дополнительные аутригеры 

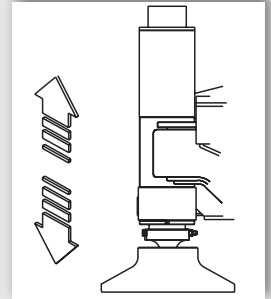
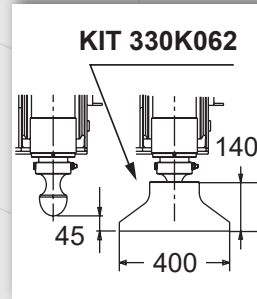
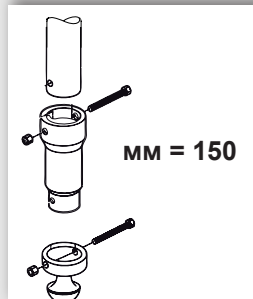
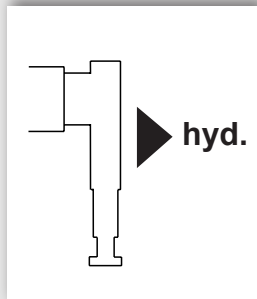
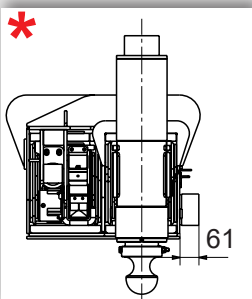

1400A203 - 1400A203/CE

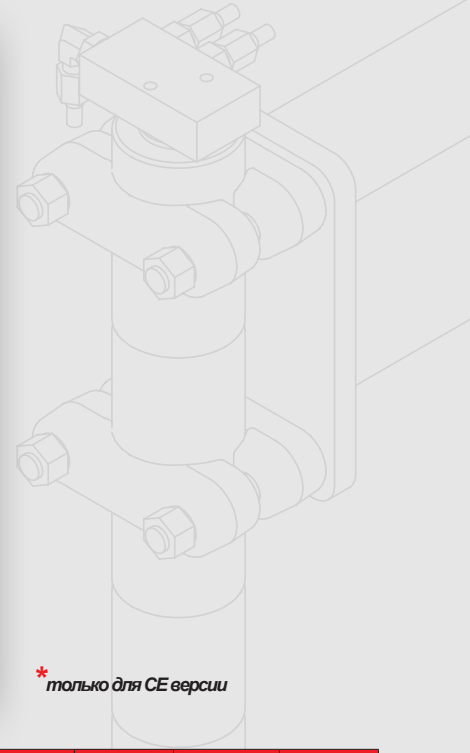
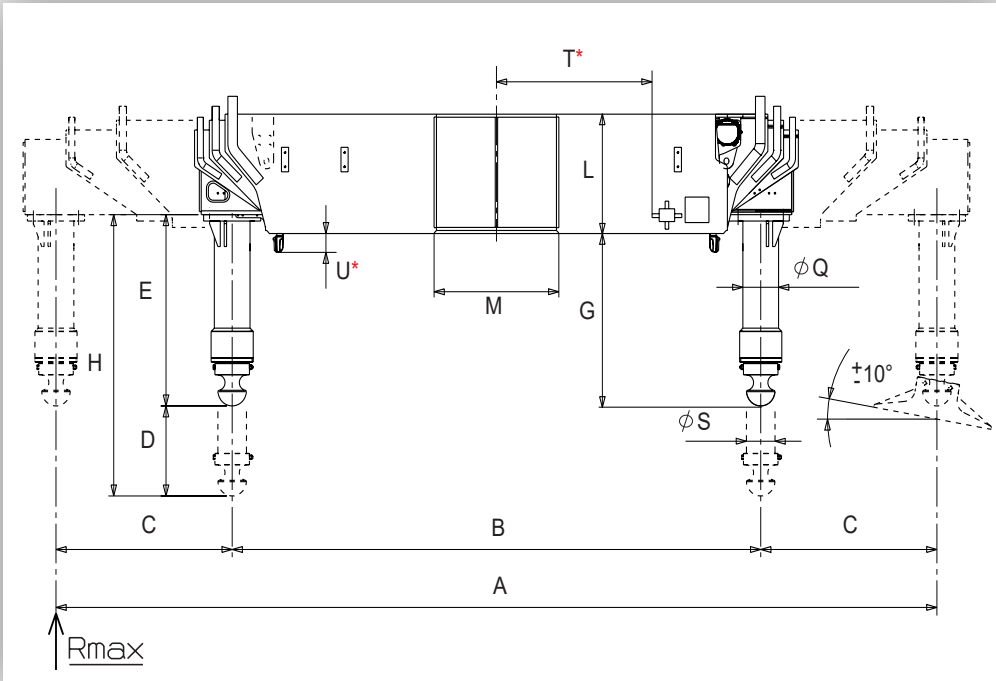

* только для CE версии

A	B	C	D	E	G	H	L	M	ϕQ	ϕS	T*	U*	
9960	2220	3870	353	750	676	1103	468	524	150	120	654	74	2450

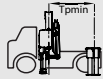

KIT 330K033

F1950RA.2 / F2150RA.2 4400 мм

36500 даН

17 кг

F1950RAL.2 / 2150RAL.2 4400 мм



Дополнительные аутригеры

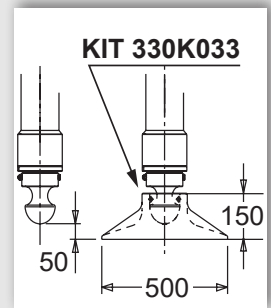
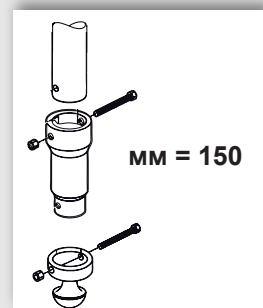
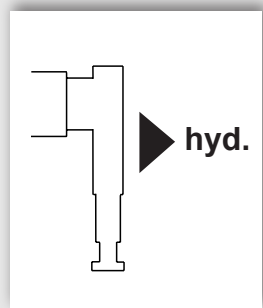
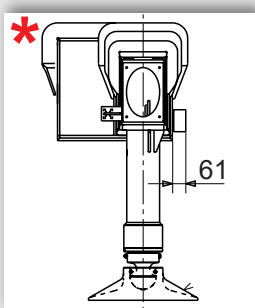

1400A303 - 1400A303/CE

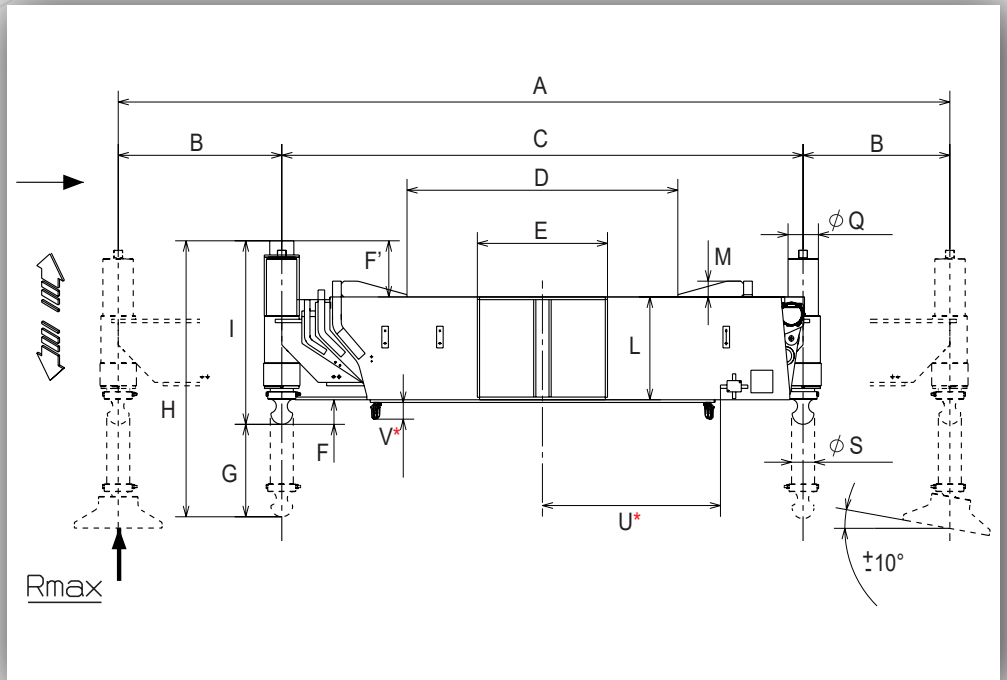

A	B	C	D	E	F	F'	G	H	I	L	M	φQ	φS	U*	V*	
10120	3870	2380	1236	594	109/362	249/4	410	1224	814	456	70	140	105	815	74	2420



F1950RA.2 / F2150RA.2 4400 мм

F1950RAL.2 / F2150RAL.2 4400 мм

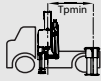

36500 даН

KIT 330K062

16 кг

Дополнительные аутригеры

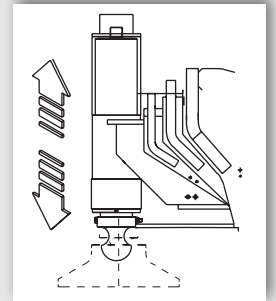
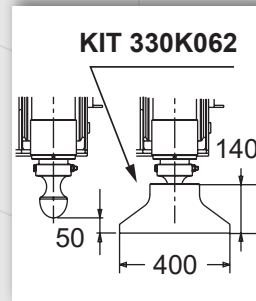
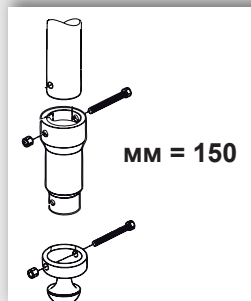
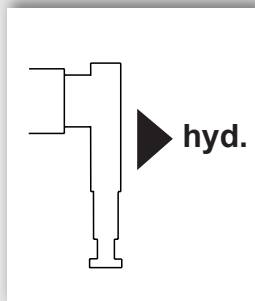
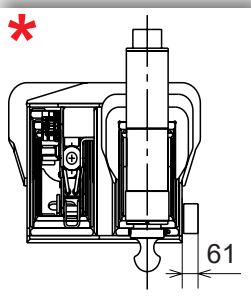

1400A313 - 1400A313/CE

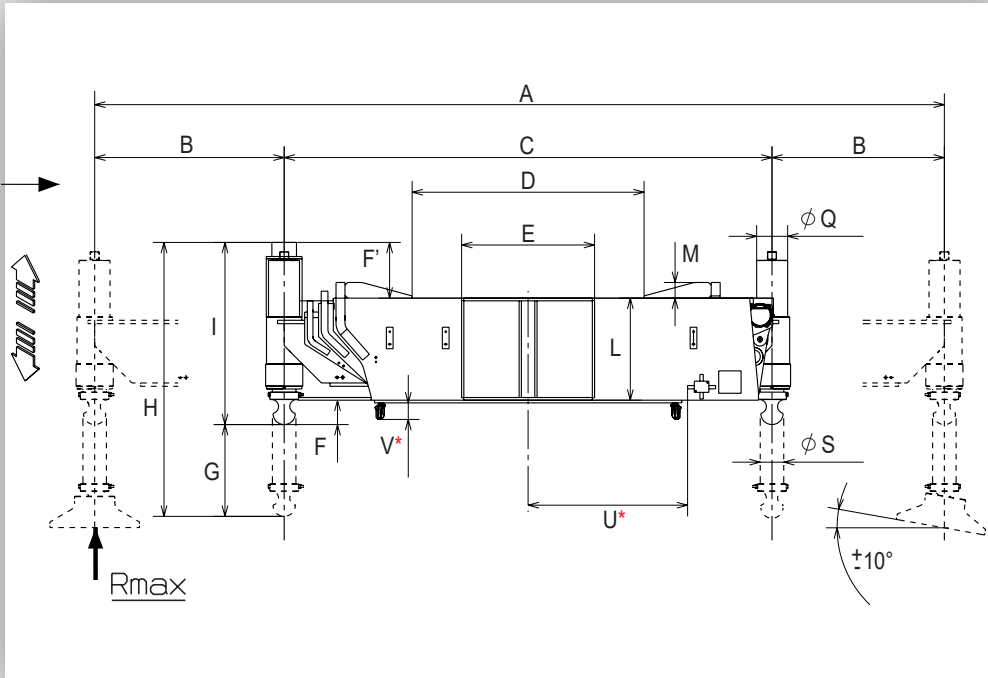

A	B	C	D	E	F	F'	G	H	I	L	M	φQ	φS	U*	V*	
9170	3495	2180	1036	594	109/362	249/-4	410	1224	814	456	70	140	105	715	74	2200

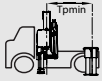

KIT 330K062

F1600RA.2 / F1650RA.2 3900 мм

36500 даН

16 кг

F1600RAL.2 / F1650RAL.2 3900 мм

F1950RA.2 / F2150RA.2 4400 мм

F1950RAL.2 / F2150RAL.2 4400 мм



Дополнительные аутригеры

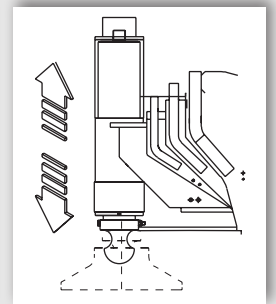
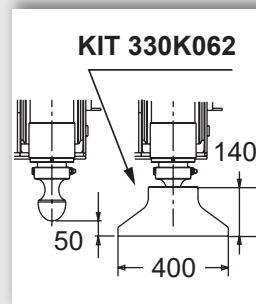
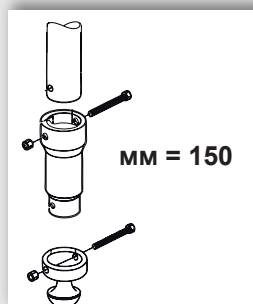
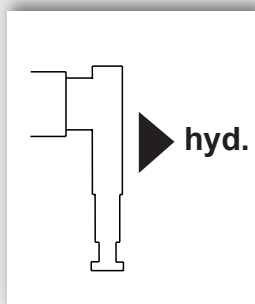
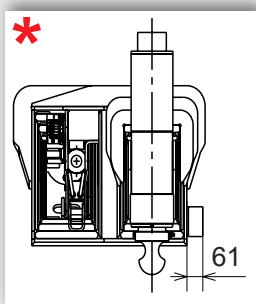

1950A203 - 1950A203/CE

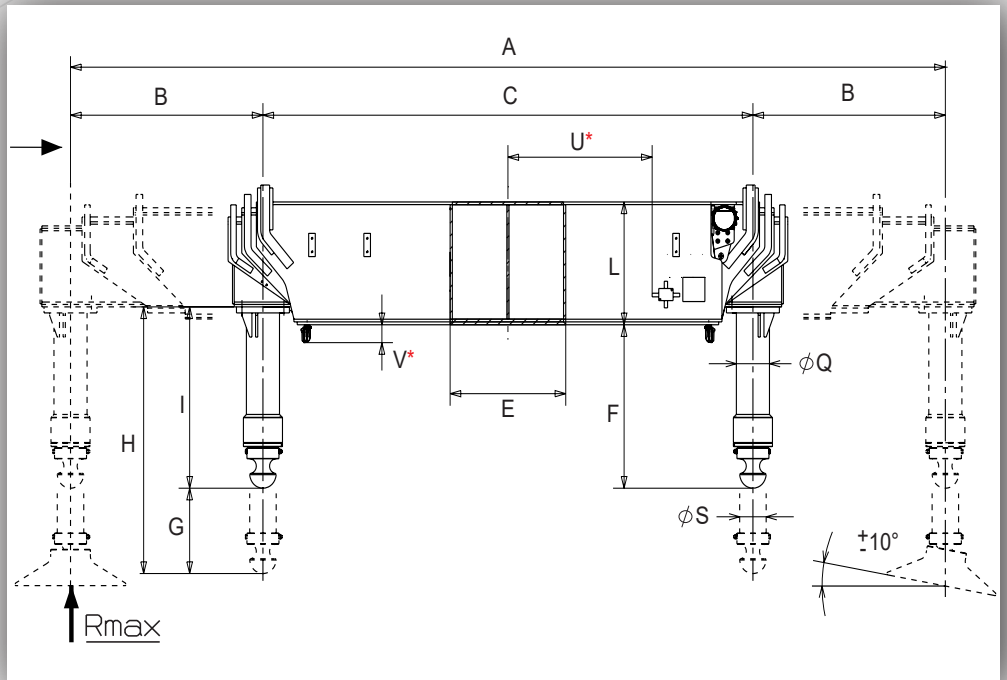

* только для CE версии

A	B	C	E	F	G	H	I	L	ϕQ	ϕS	U*	V*	
10690	4235	2220	524	676	353	1103	750	508	150	120	654	74	2500

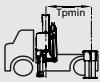

F1950RA.2 / F2150RA.2 2000 мм

F1950RAL.2 / F2150RAL.2 2000 мм



36500 даН

KIT 330K033

17 кг

Дополнительные аутригеры 

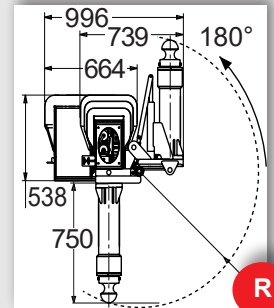
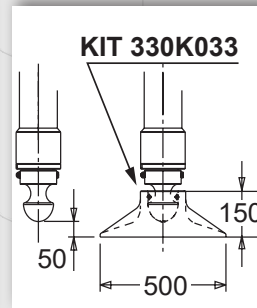
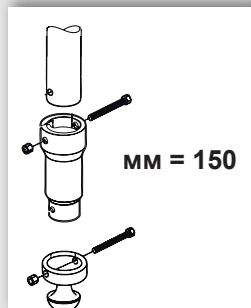
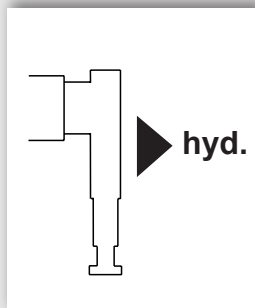
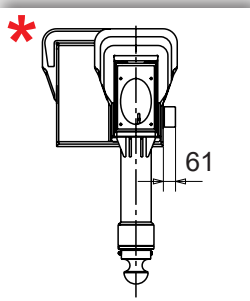

ОПЦИОННО

R 854



Максимальная реакция дополнительного аутригера



Максимальная реакция дополнительного аутригера с поворотным гидроцилиндром

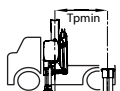

Минимальное расстояние между центром колонны и дополнительным аутригером

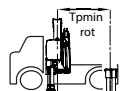

Минимальное расстояние между центром колонны и дополнительным аутригером с поворотным гидроцилиндром



Вес дополнительного аутригера



Модель крана



Механическое выдвигание

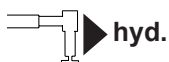

Гидравлическое выдвигание



Поворотный



Длинный



Короткий

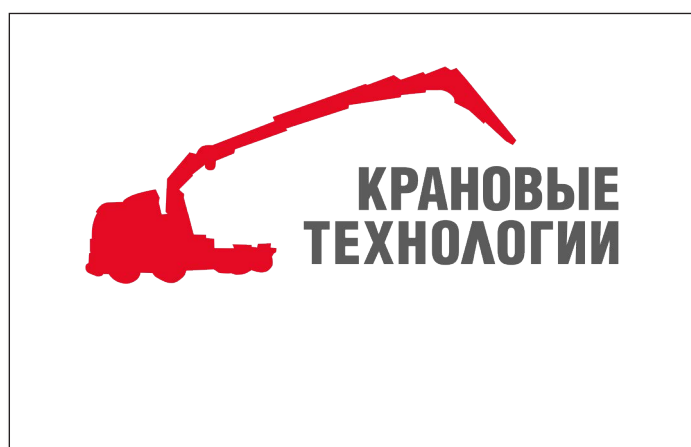

Тел.: +375 29 661 66 99,

+375 33 661 66 99

Crane-Technologies@yandex.by

fassi.by